

NOTE:

- 1.MATERIAL:  
HOUSING:THERMOPLASTIC  
CONTACTS:COPPER ALLOY
- 2.PLATING:SEE ORDERING INFORMATION
- 3.RATING:  
OPERATING VOLTAGE:50V  
CURRENT RATING:0.3A  
OPERATING TEMPERATURE:-25°C ~ +85°C

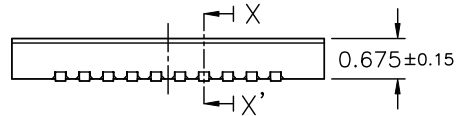

PCB Layout

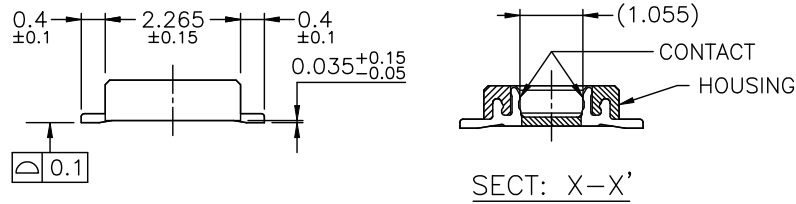

MATED DRAWING(REF.)

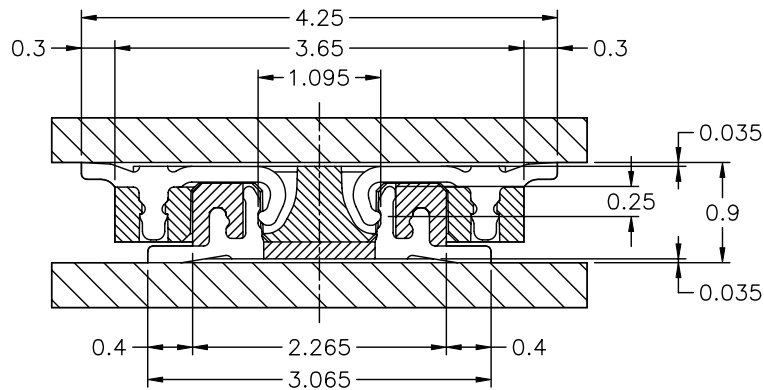
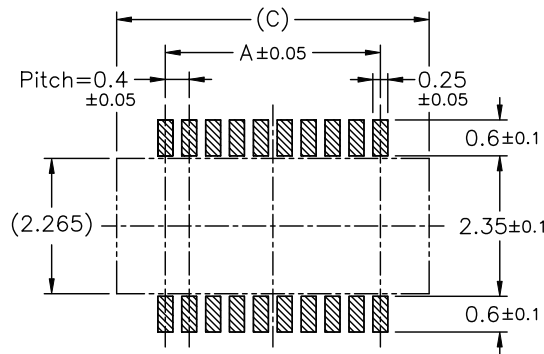

SCALE: 15/1

No. of Contacts	Catalog No.	DIM. A	DIM. B	DIM. C
10	NP0410-P02X-010	1.6	2.43	3.23
12	NP0410-P02X-012	2.0	2.83	3.63
14	NP0410-P02X-014	2.4	3.23	4.03
16	NP0410-P02X-016	2.8	3.63	4.43
18	NP0410-P02X-018	3.2	4.03	4.83
20	NP0410-P02X-020	3.6	4.43	5.23
22	NP0410-P02X-022	4.0	4.83	5.63
24	NP0410-P02X-024	4.4	5.23	6.03
26	NP0410-P02X-026	4.8	5.63	6.43
28	NP0410-P02X-028	5.2	6.03	6.83
30	NP0410-P02X-030	5.6	6.43	7.23
32	NP0410-P02X-032	6.0	6.83	7.63
34	NP0410-P02X-034	6.4	7.23	8.03
36	NP0410-P02X-036	6.8	7.63	8.43
38	NP0410-P02X-038	7.2	8.03	8.83
40	NP0410-P02X-040	7.6	8.43	9.23
42	NP0410-P02X-042	8.0	8.83	9.63
44	NP0410-P02X-044	8.4	9.23	10.03
46	NP0410-P02X-046	8.8	9.63	10.43
48	NP0410-P02X-048	9.2	10.03	10.83
50	NP0410-P02X-050	9.6	10.43	11.23
52	NP0410-P02X-052	10.0	10.83	11.63
54	NP0410-P02X-054	10.4	11.23	12.03
56	NP0410-P02X-056	10.8	11.63	12.43
58	NP0410-P02X-058	11.2	12.03	12.83
60	NP0410-P02X-060	11.6	12.43	13.23
62	NP0410-P02X-062	12.0	12.83	13.63
64	NP0410-P02X-064	12.4	13.23	14.03
66	NP0410-P02X-066	12.8	13.63	14.43
68	NP0410-P02X-068	13.2	14.03	14.83
70	NP0410-P02X-070	13.6	14.43	15.23
72	NP0410-P02X-072	14.0	14.83	15.63
74	NP0410-P02X-074	14.4	15.23	16.03
76	NP0410-P02X-076	14.8	15.63	16.43
78	NP0410-P02X-078	15.2	16.03	16.83
80	NP0410-P02X-080	15.6	16.43	17.23

RoHS Compliant

TOLERANCES ARE

**MORETHANALL**  
PCB CONNECTORS  
Cable ASSEMBLIES

DRAWING BY CY

CHECKED BY GENIUS

UNIT/mm

SCALE 1:1

DATE

SIZE A4

PJECTION

X, ±  
X ± 0.20  
.XX ± 0.10  
.XXX ±  
ANG ±

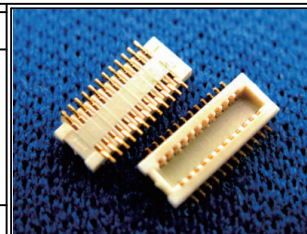

ORDER INFORMATION

NP0410-P02X-xxx-LF

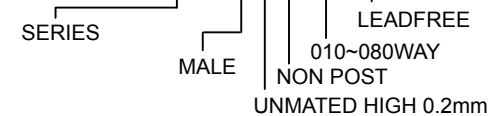

煜倫股份有限公司

www.morethanall.com

DESCRIPTION: 0.4mm Pitch B-T0-B Connector

# Recommended metal mask pattern

Metal mask thickness : 0.1mm

• MALE

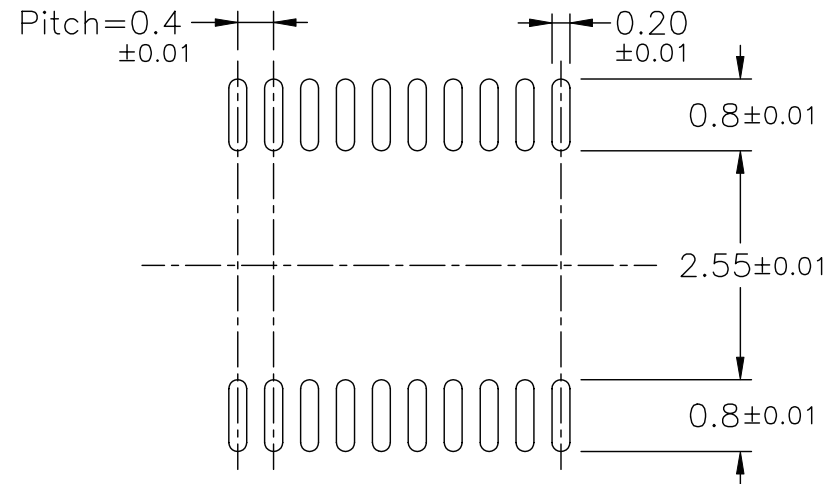

**MORETHANALL**  
PCB CONNECTORS  
Cable ASSEMBLIES

煜倫股份有限公司

www.morethanall.com

RoHS Compliant

DRAWING BY CY

CHECKED BY GENIUS

UNIT/ mm

SCALE 1:1

DATE

SIZE A4

TOLERANCES ARE

X. ±  
.X ± 0.20  
.XX ± 0.10  
.XXX ±  
ANG ±

PJECTION

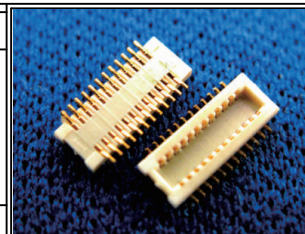

ORDER INFORMATION

NP0410-P02X-xxx-LF  
SERIES MALE LEADFREE  
010~080WAY  
NON POST  
UNMATED HIGH 0.2mm

DESCRIPTION: 0.4mm Pitch B-TO-B Connector