

PART NO.	A	B	C	D	E	F	G
CVS-W-20	9.50	11.30	16.25	14.47	14.30	10.60	18.20
CVS-W-30	14.50	16.30	21.25	19.47	19.30	15.60	23.20
CVS-W-40	19.50	21.30	26.25	24.47	24.30	20.60	28.20

30P

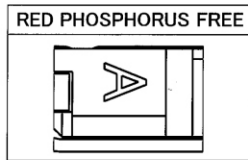

DETAIL P
S= 20 : 1

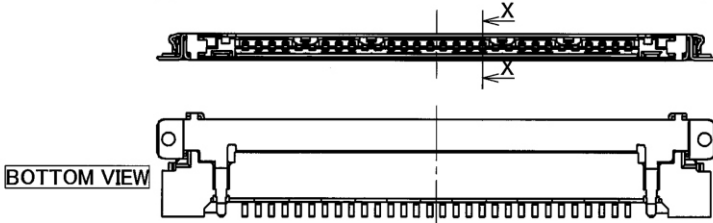
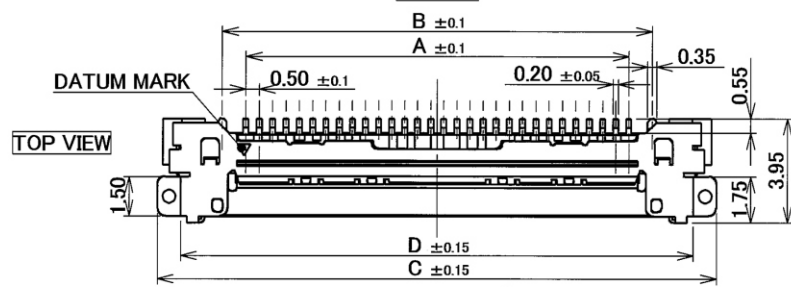
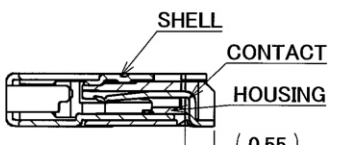

断面図 X-X
スケール 10 : 1

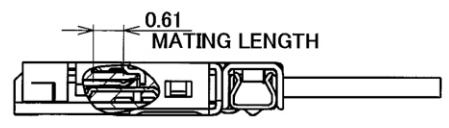
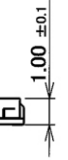

MATING CONDITION

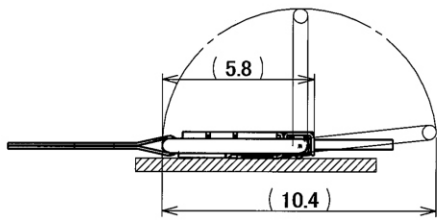

PULL-BAR MOVEMENTS

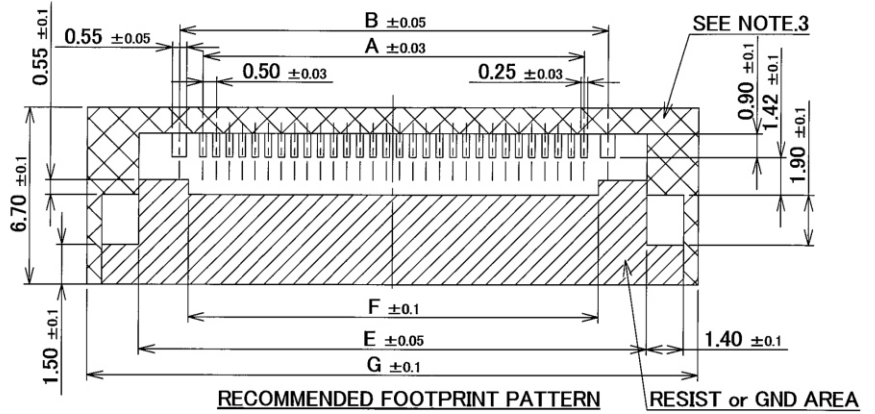

RECOMMENDED FOOTPRINT PATTERN RESIST or GND AREA

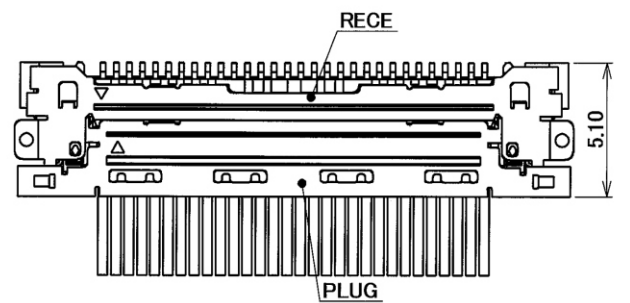

20P

40P

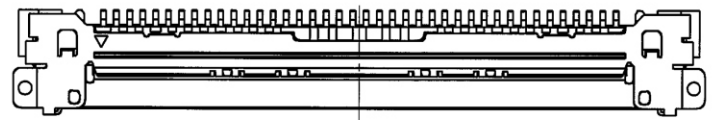

- NOTES:
 1.MATERIAL & FINISH
 HOUSING : LCP(REDFOSPHORUS FREE), UL94V-0, BLACK
 CONTACT: PHOSPHER BRONZE / Au OVER Ni
 SHELL : PHOSPHER BRONZE / Au OVER Ni
 2.COPLANARITY : 0.1MAX.

RoHS Compliant

TOLERANCES ARE

- X, ±
- .X ±
- .XX ±
- .XXX ±
- ANG ±

DRAWING BY CY
 CHECKED BY GENIUS
 UNIT / mm SCALE 1 : 1
 DATE
 SIZE A4 PPROJECTION

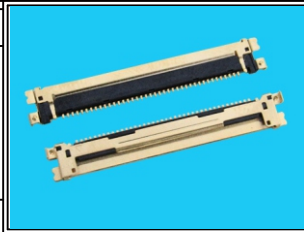

ORDER INFORMATION

CVS-W-xx-LF
 SERIES | LEADFREE
 20.30.40WAY
 90°SMT

DESCRIPTION:

MORETHANALL
 PCB CONNECTORS
 Cable ASSEMBLIES
 煜倫股份有限公司
 www.morethanall.com