

**RECOMMENDED PCB LAYOUT**  
TOP VIEW

**NOTES:**

**1. MATERIAL:**

- 1) SOCKET HOUSING: LCP,UL94V-0,BLACK;
- 2) PICK AND PLACE COVER: LCP,UL94V-0,BLACK;
- 3) CONTACT: COPPER ALLOY;
- 4) SOLDER BALL: SAC305 LEAD-FREE,  $\phi$  0.45MM;

**2. FINISH:**

CONTACT: AU PLATING ON CONTACT AREA (DETAIL SEE TABLE 1); 50U"MIN MATTE TIN PLATING ON SOLDER TAIL, 50U"MIN NICKEL UNDER-PLATING OVER ALL;

**3. HSF COMPLIANT (RoHS 2.0,HF);**

**4. DATE CODE: X XX X X X**

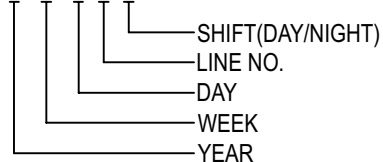

**RoHS Compliant**

TOLERANCES ARE

**MORETHANALL**  
PCB CONNECTORS  
Cable ASSEMBLIES

煜倫股份有限公司

www.morethanall.com

DRAWING BY CY

CHECKED BY GENIUS

UNIT / mm SCALE 1 : 1

DATE

SIZE A4

X,  $\pm$   
.X  $\pm$  0.35  
.XX  $\pm$  0.25  
.XXX  $\pm$  0.15  
ANG  $\pm$

PJECTION

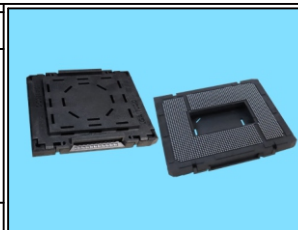

**ORDER INFORMATION**

**LGA08-V70-1700-LF**

SERIES | LEADFREE  
1700 WAY  
HIGH 7.04mm  
180°SMT

DESCRIPTION: LGA 1700 SKT

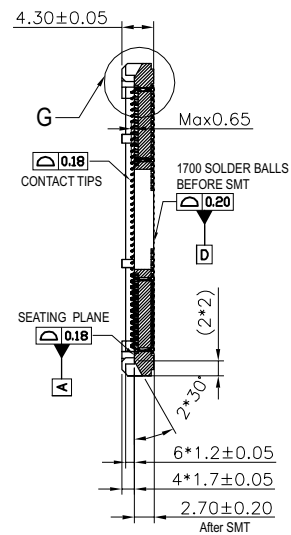
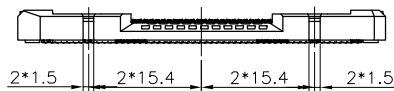
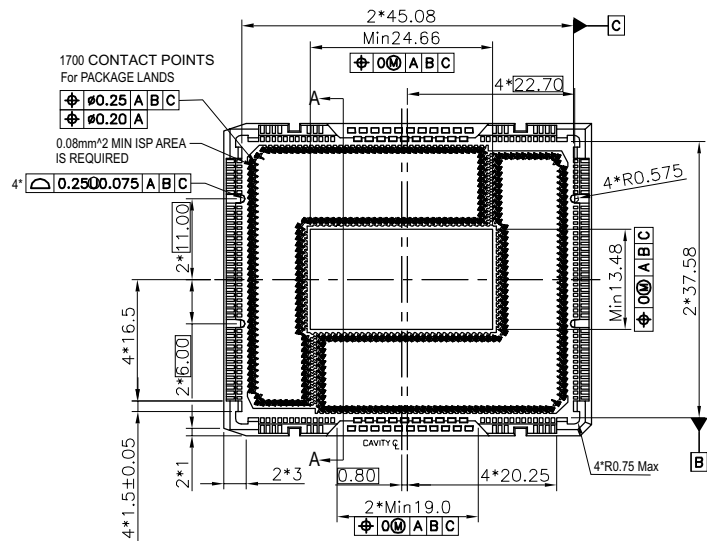

SECTION A-A

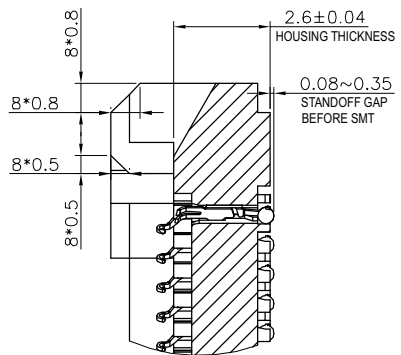

DETAIL G  
SCALE 5:1

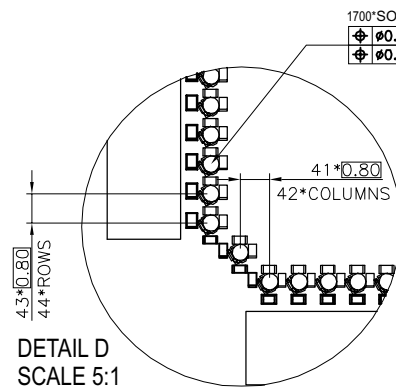
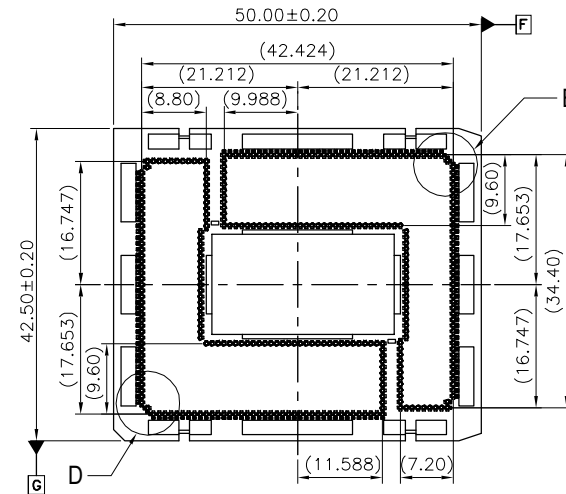

DETAIL D  
SCALE 5:1

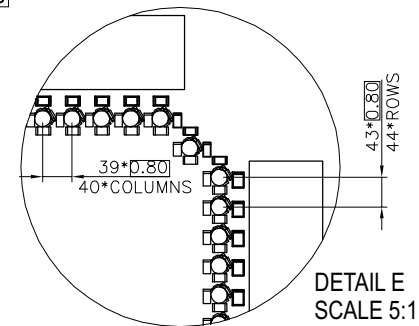

DETAIL E  
SCALE 5:1

**RoHS Compliant**

TOLERANCES ARE

**MORETHANALL**  
PCB CONNECTORS  
Cable ASSEMBLIES

DRAWING BY CY  
 CHECKED BY GENIUS  
 UNIT / mm    SCALE 1 : 1  
 DATE  
 SIZE A4    PPROJECTION

X,  $\pm$   
 .X  $\pm 0.35$   
 .XX  $\pm 0.25$   
 .XXX  $\pm 0.15$   
 ANG  $\pm$

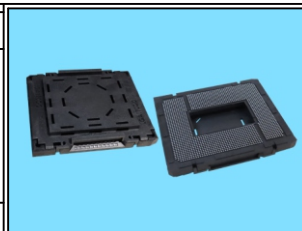

**ORDER INFORMATION**

**LGA08-V70-1700-LF**  
 SERIES    LEADFREE  
 1700 WAY  
 HIGH 7.04mm  
 180°SMT

DESCRIPTION: LGA 1700 SKT

煜倫股份有限公司

www.morethanall.com

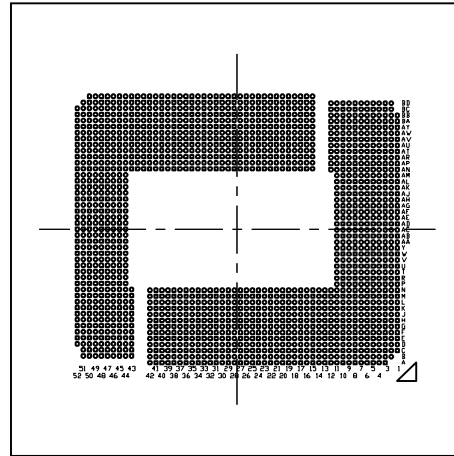

0.13±0.15

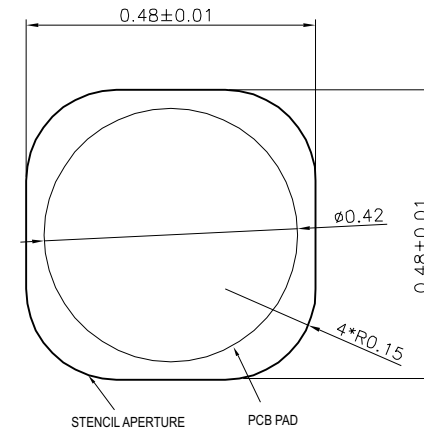

SCALE  
80 : 1

**SOLDER TEMPERATURE REQUEST:**

- 1.MIN SOLDER JOINT PEAK TEMPERATURE : 235°C;
- 2.MAX SOLDER JOINT PEAK TEMPERATURE : 250°C;
- 3.SOAK TIME : < 100 SEC BETWEEN 150 ~ 200°C;
- 4.TIME ABOVE LIQUIDUS (TAL) : 60 ~ 120 SEC ABOVE 220°C;
- 5.TEMPERATURE RAMP RATE : 3°C/SEC MAX;
- 6.THE CONCENTRATION OF OXYGEN IN THE REFLOW OVEN IS 3000 PPM MAX.

**RoHS Compliant**

TOLERANCES ARE

**MORETHANALL**  
PCB CONNECTORS  
Cable ASSEMBLIES

煜倫股份有限公司

www.morethanall.com

DRAWING BY CY

CHECKED BY GENIUS

UNIT / mm SCALE 1 : 1

DATE

SIZE A4

X, ±  
.X ± 0.35  
.XX ± 0.25  
.XXX ± 0.15  
ANG ±

PJECTION

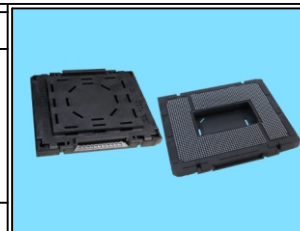

**ORDER INFORMATION**

**LGA08-V70-1700-LF**

SERIES | LEADFREE  
1700 WAY  
HIGH 7.04mm  
180°SMT

DESCRIPTION: LGA 1700 SKT

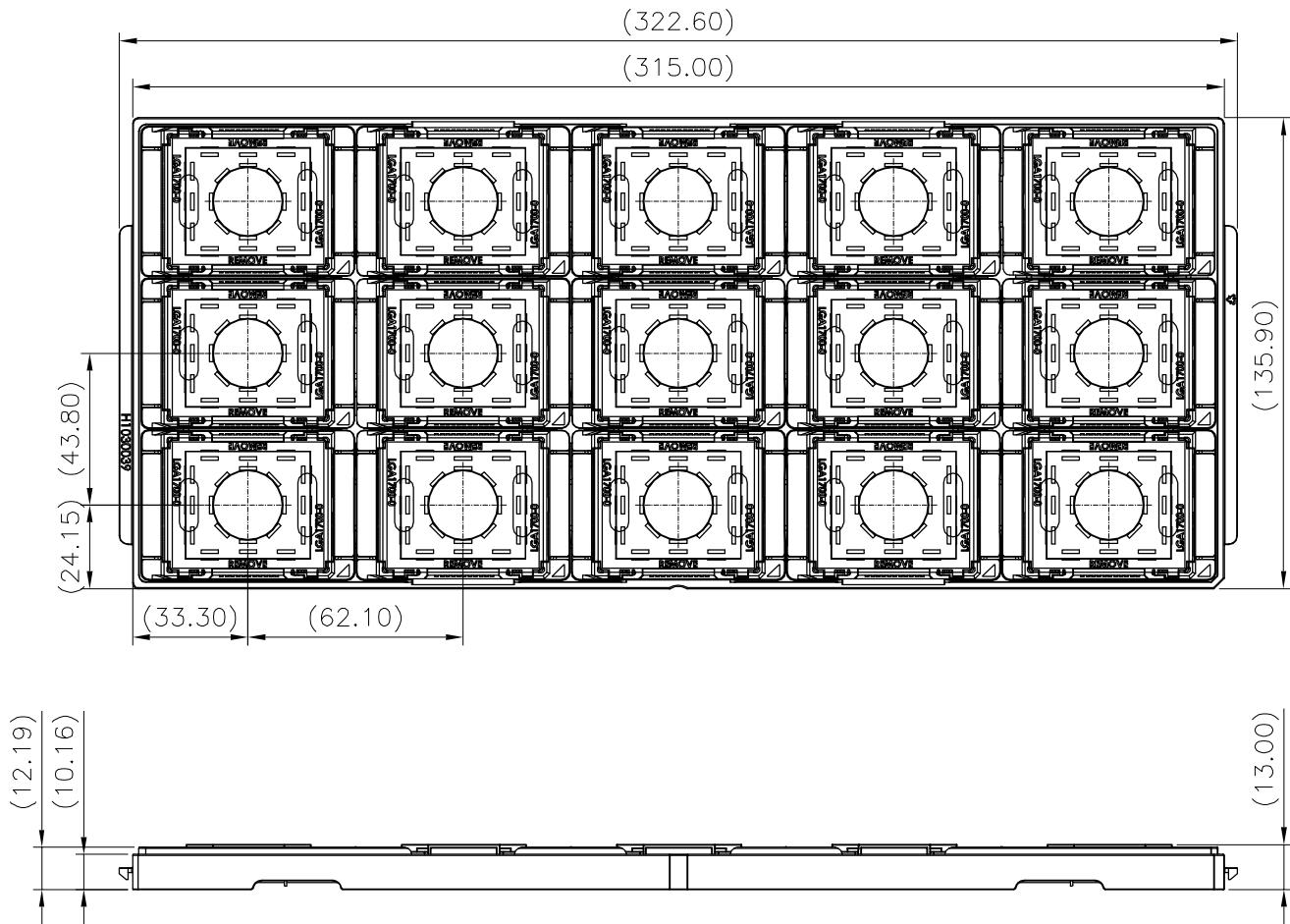

**Storage Requirements:**

1. 60%RH, 30°C.
2. Validity period before open: 1 year
3. Validity period after open: 24 accumulated hrs under 60%RH, 30°C.  
Vacuum pack the unused sockets, store under 60%RH, 30°C.
4. Do not bake before SMT.

**RoHS Compliant**

TOLERANCES ARE

**MORETHANALL**  
PCB CONNECTORS  
Cable ASSEMBLIES

煜倫股份有限公司

www.morethanall.com

DRAWING BY CY

CHECKED BY GENIUS

UNIT / mm SCALE 1 : 1

DATE

SIZE A4

X, ±  
.X ± 0.35  
.XX ± 0.25  
.XXX ± 0.15  
ANG ±

PJECTION

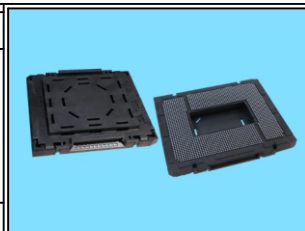

**ORDER INFORMATION**

**LGA08-V70-1700-LF**

SERIES | LEADFREE  
1700 WAY  
HIGH 7.04mm  
180°SMT

DESCRIPTION: LGA 1700 SKT