

Material:

* Insulation:

High temperature plastic UL 94V-0

* Contact: Phosphor Bronze

* Pick & Place Pad:

Nylon 6T UL 94V-0 Color Nature

DIM.A= 1.27 x No. of Spaces

DIM.B= DIM.A + 3.3

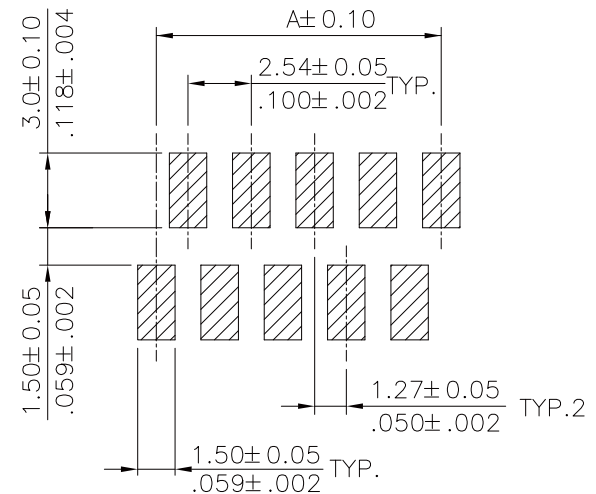
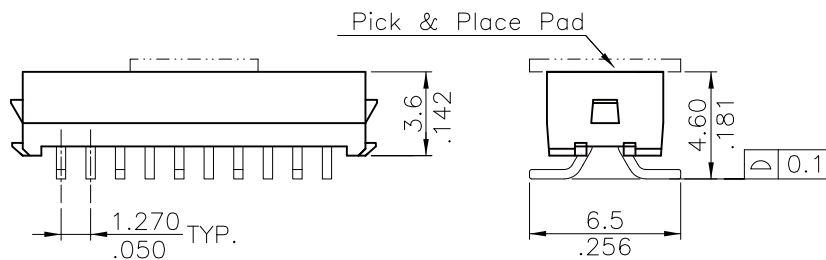
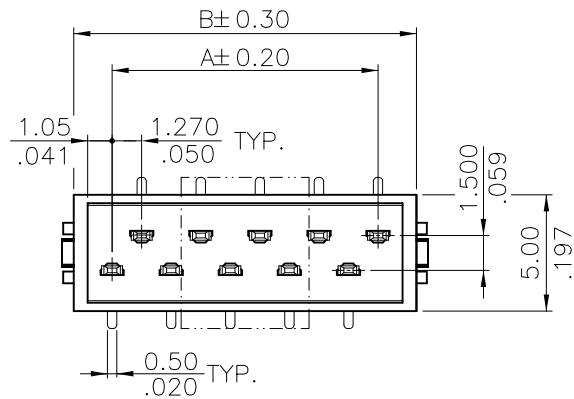

△ Solder Pad Pattern

RoHS Compliant

TOLERANCES ARE

MORETHANALL
PCB CONNECTORS
Cable ASSEMBLIES

煜倫股份有限公司

www.morethanall.com

DRAWING BY CY

CHECKED BY GENIUS

UNIT/mm SCALE 1:1

DATE

SIZE A4

X. ±
.X ±
.XX ±
.XXX ±
ANG ±

PJECTION

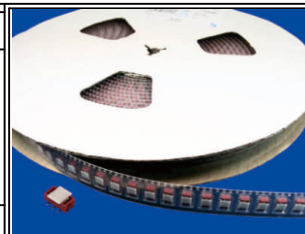

ORDER INFORMATION

MIM-BVCR-xx-LF



DESCRIPTION:

NOTES:

1. 10 sprocket hole pitch cumulative tolerance $\pm 0.20\text{mm}$.
2. Carrier camber not to exceed 1 mm in 100 mm.
3. Material :Transparent Anti-static Polysyrene.
4. All dimensions meet EIA-481-3 requirements.
5. Thickness : $0.40\pm 0.05\text{mm}$.
6. Packing length per 22" Reel : 30.6 Meters.
7. Component load per 13" Reel :1000 pcs.

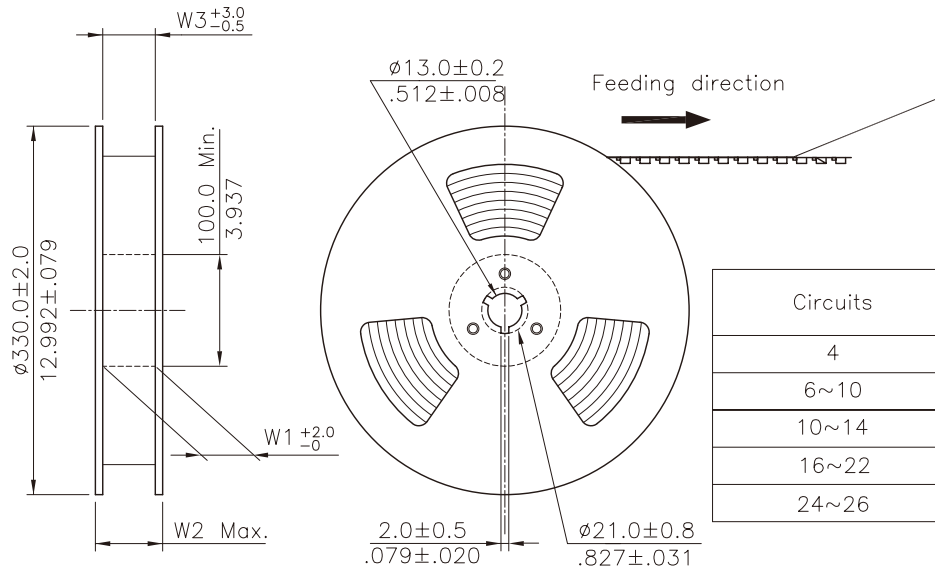

Circuits	Dimension					Packing (Reel/Caton)
	E	F	W1	W2	W3	
4	16.0(.630)	-	16.5(.650)	22.5(.886)	16.5(.650)	11
6~10	24.0(.945)	-	24.5(.965)	30.5(1.201)	24.5(.965)	9
10~14	32.0(1.260)	28.40(1.118)	32.5(1.280)	38.5(1.516)	32.5(1.280)	7
16~22	44.0(1.732)	40.40(1.596)	44.5(1.752)	50.5(1.988)	44.5(1.752)	5
24~26	56.0(2.205)	52.40(2.063)	56.5(2.224)	62.5(2.461)	56.5(2.224)	4

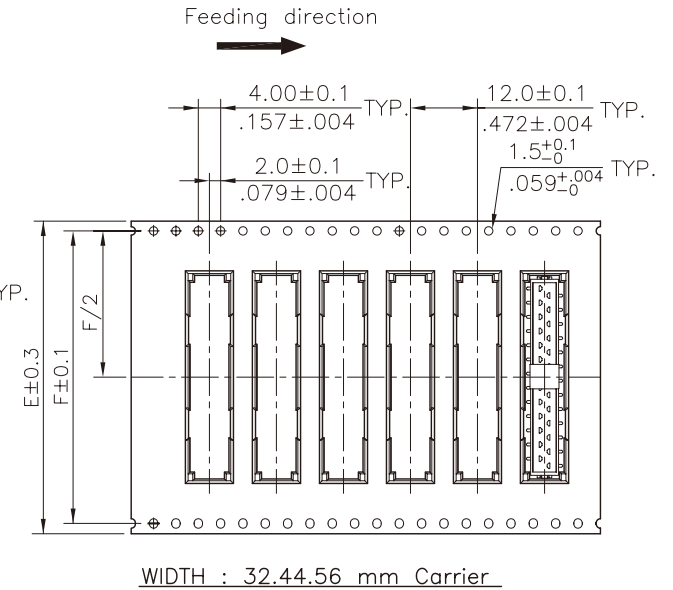
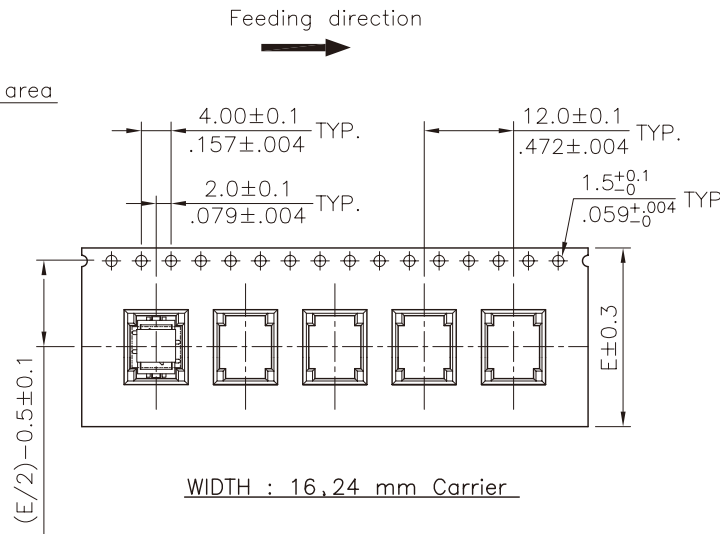
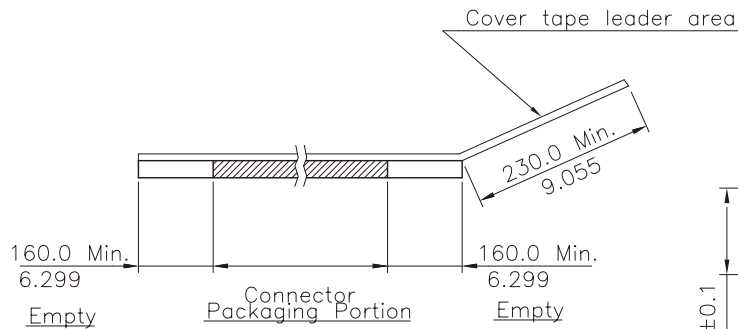

MORETHANALL
PCB CONNECTORS
Cable ASSEMBLIES

煜倫股份有限公司

www.morethanall.com

RoHS Compliant

DRAWING BY CY

CHECKED BY GENIUS

UNIT/mm SCALE 1:1

DATE

SIZE A4

TOLERANCES ARE

X. \pm
X. \pm
.XX \pm
.XXX \pm
ANG \pm

PJECTION

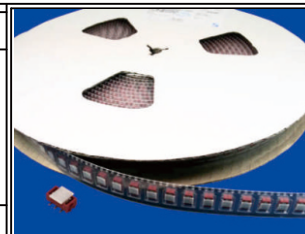

ORDER INFORMATION

MIM-BVCR-xx-LF



DESCRIPTION: