

DETAIL E

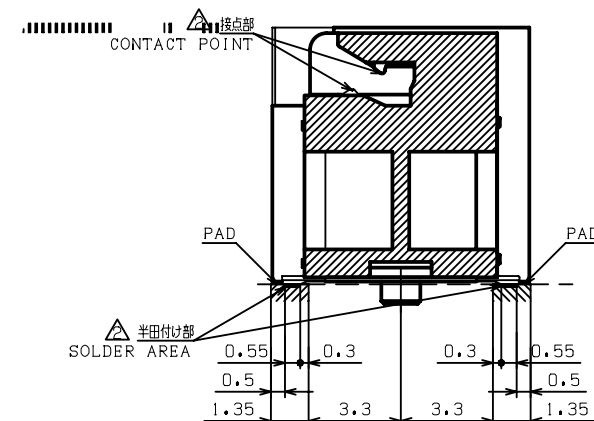

NOTES.

1. 材質：ハウジング：LCP樹脂、UL94V-0、色：黒色
 コンタクト：銅合金
 メタルラッチ：ステンレス
 MATERIAL: HOUSING: LCP, UL94V-0, COLOR: BLACK
 CONTACT: COPPER ALLOY
 METAL LATCH: SUS
- △ メッキ：コンタクト（接点部、半田付け部）：金メッキ0.0075μmMIN、ニッケル下地1.5μmMIN。
 PLATING: CONTACT (CONTACT POINT, SOLDER AREA):
 Au PLATE 0.0075μm MIN, Ni UNDER PLATE 1.5μm MIN.
- △ コネクタを平坦面に置き、端子半田付け部の厚きは、0.1mm以下
 MUST BE MEASURED FLOATING AMOUNT OF CONTACT TAILS
 FROM DATUM SURFACE IS 0.1mm MAX.

- △ 倍率適用外寸法
 NOT TO SCALE.
- △ 公差非累積
 TOLERANCES NON-CUMULATIVE
- △ 他社のソケット用
 FOR SOCKET OF THE OTHER COMPANIES

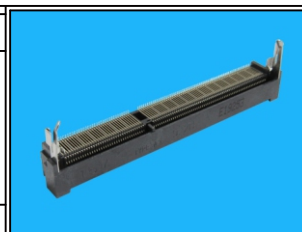

RoHS Compliant

TOLERANCES ARE

MORETHANALL
 PCB CONNECTORS
 Cable ASSEMBLIES

煜倫股份有限公司

www.morethanall.com

DRAWING BY CY

CHECKED BY GENIUS

UNIT / mm

SCALE 1:1

DATE

SIZE A4

PJECTION

X, ±
 .X ±
 .XX ±
 .XXX ±
 ANG ±

ORDER INFORMATION

SDM6-W92V15-72A3-LF

SERIES | LEADFREE
 | 1.5V | 72+132 WAY
 | HIGH:9.2mm |
 | 90°SMT |

DESCRIPTION: DDR S.O DIMM SOCKET H=9.2 TYPE A SMALL LATCH FOR 204PIN DDR S.O DIMM(DDR3)

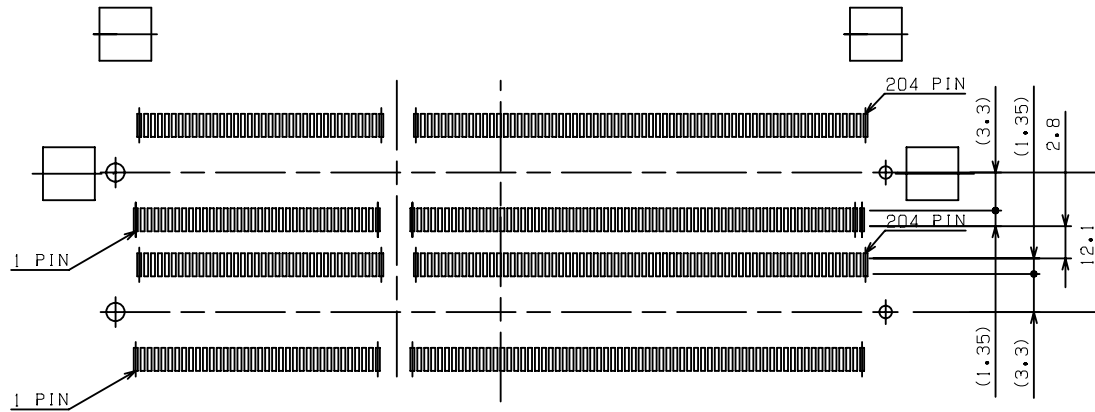

推奨基板レイアウト寸法
RECOMMENDED MOUNTING
P.C. BOARD PATTERN LAYOUT DIM.

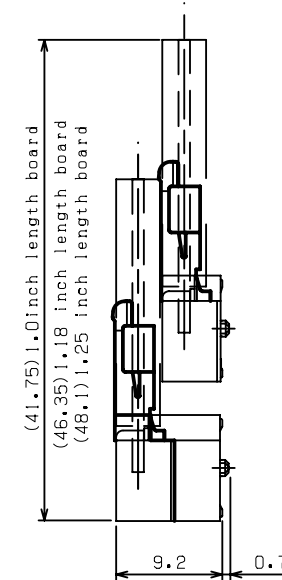
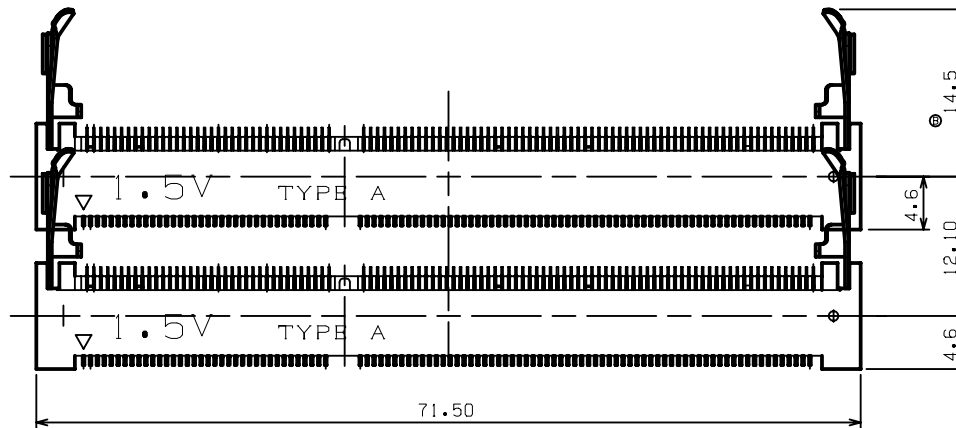

Combination Dimension for H=5.2 connector

(Only the combination of the (H=5.2) and (H=9.2) is possible.)

RoHS Compliant

TOLERANCES ARE

MORETHANALL
PCB CONNECTORS
Cable ASSEMBLIES

DRAWING BY CY

X.±

CHECKED BY GENIUS

.X±

UNIT / mm

SCALE 1:1

.XX±

DATE

.XXX±

ANG±

SIZE A4

PJECTION

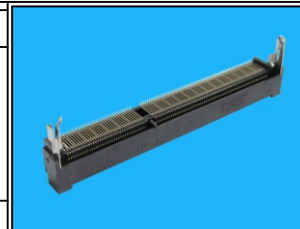

ORDER INFORMATION

SDM6-W92V15-72A3-LF

SERIES

LEADFREE

1.5V

HIGH:9.2mm

90°SMT

72+132 WAY

煜倫股份有限公司

www.morethanall.com

DESCRIPTION: DDR S.O DIMM SOCKET H=9.2 TYPE A SMALL LATCH FOR 204PIN DDR S.O DIMM(DDR3)

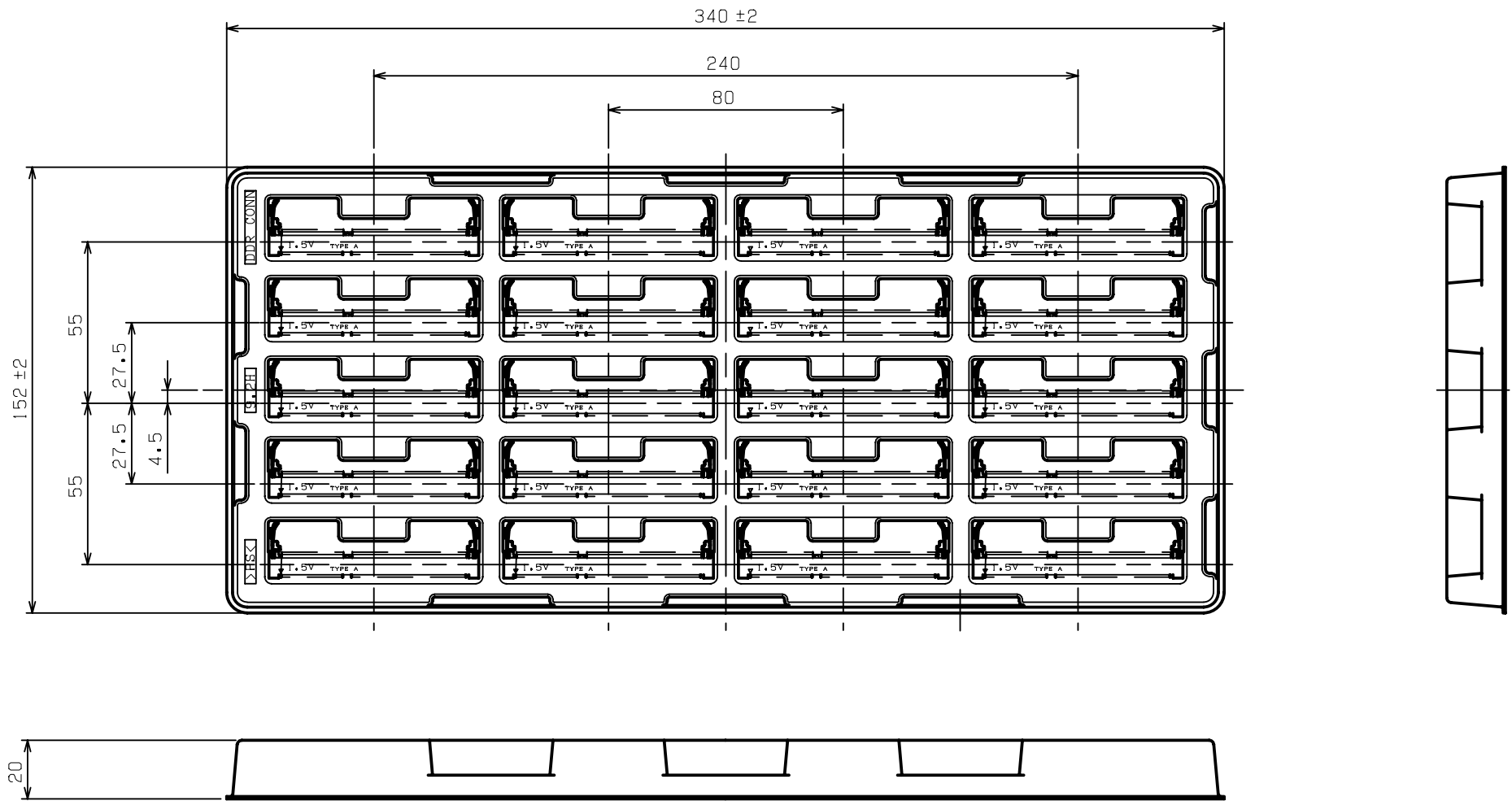

® SOFT TRAY PACKAGING

QT'Y=20PCS

RoHS Compliant

TOLERANCES ARE

MORETHANALL
PCB CONNECTORS
Cable ASSEMBLIES

DRAWING BY CY

X. ±

CHECKED BY GENIUS

.X ±

UNIT / mm

SCALE 1 : 1

.XX ±

DATE

.XXX ±

ANG ±

SIZE A4

PJECTION

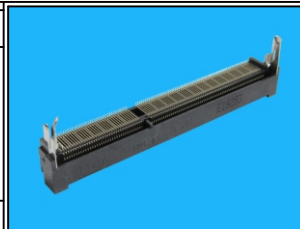

ORDER INFORMATION

SDM6-W92V15-72A3-LF

SERIES

1.5V

LEADFREE

HIGH:9.2mm

90°SMT

72+132 WAY

煜倫股份有限公司

www.morethanall.com

DESCRIPTION: DDR S.O DIMM SOCKET H=9.2 TYPE A SMALL LATCH FOR 204PIN DDR S.O DIMM(DDR3)