

Specifications  
 Current Rating: 3Amp  
 Insulation Resistance: 1000MΩ Min.  
 Dielectric Withstanding: 600V AC/DC  
 Contact Resistance: 20mΩ Max.  
 Operating Temperature: -40°C to +105°C

Materials  
 Contact Material: Phosphor Bronze  
 Insulation Material: Polyester, UL 94V-0  
 P.B.T  
 All materials must be GP materials

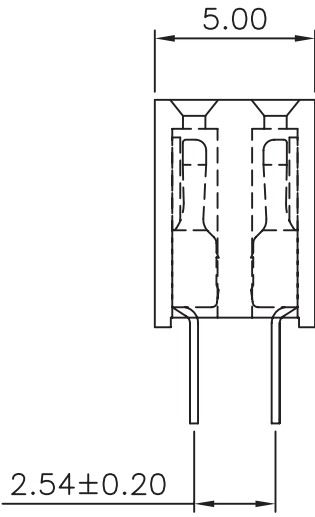

Recommended P.C.Board  
 Hole Layout

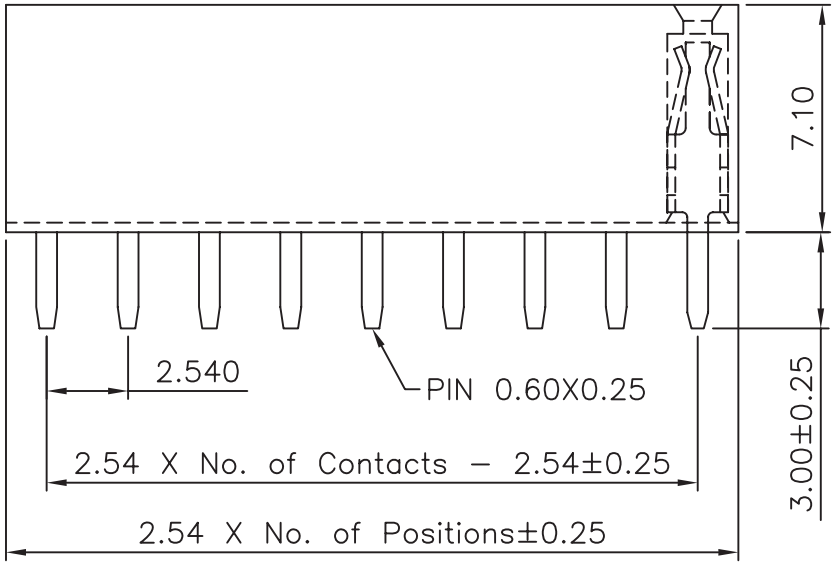
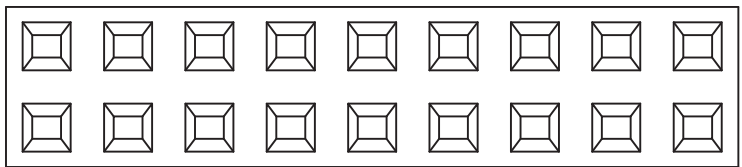
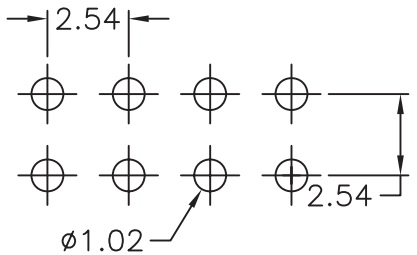

RoHS Compliant

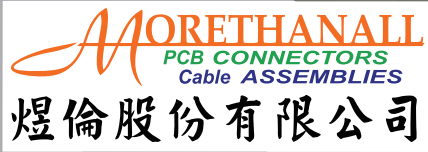

www.morethanall.com

DRAWING BY CY		TOLERANCES ARE X, ± .X ± 0.38 .XX ± 0.25 .XXX ± ANG ±
CHECKED BY GENIUS		
UNIT/ mm	SCALE 1:1	
DATE		
SIZE A4	P PROJECTION	

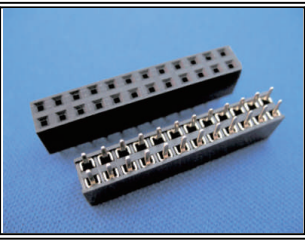

ORDER INFORMATION

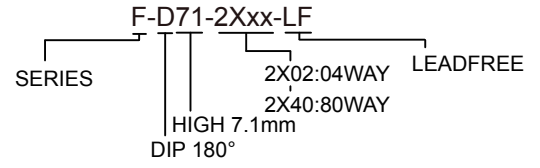

DESCRIPTION: 2.54 FEMALE HEADER DIP TYPE BASE 7.10H