

SPECIFICATION

MATERIAL

Insulator: Thermoplastic
 Contacts: Copper Alloy
 Shell: Steel
 O-ring: Silicone
 Sealant: Epoxy-Resin
 Rivet: Copper Alloy

CONTACT PLATING

Underplate :50u"~150u" Nickel
 Contact Area :1u"~30u" Selective Gold
 Rivet :50u"~100u" Nickel

ELECTRICAL

Operation Voltage :250 VAC Max
 Current Rating :3 Amps Max
 Contact Resistance :15 Mohms Min 500 VDA
 Dielectric Withstanding Voltage 1000 VAC/Minute
 Temperature Range :-55°C TO +105°C

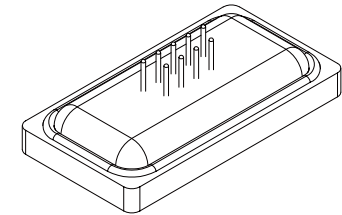

DIM FOR "X"

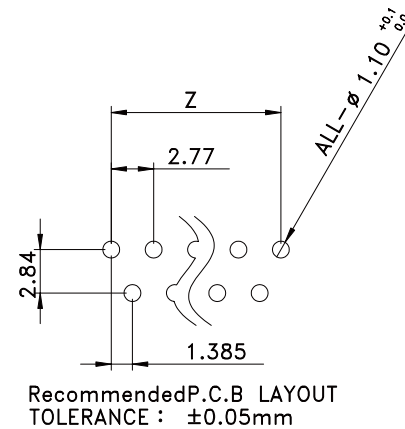
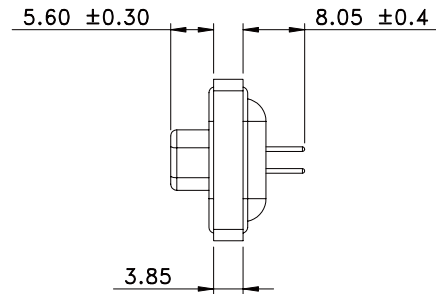
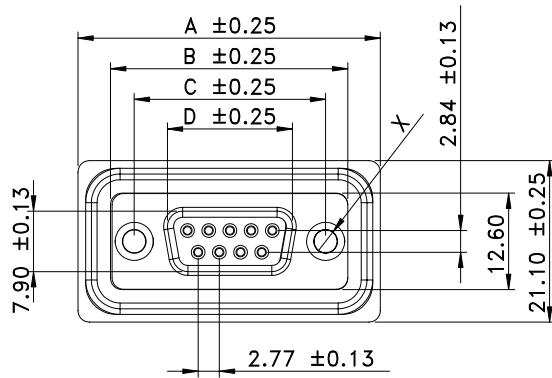
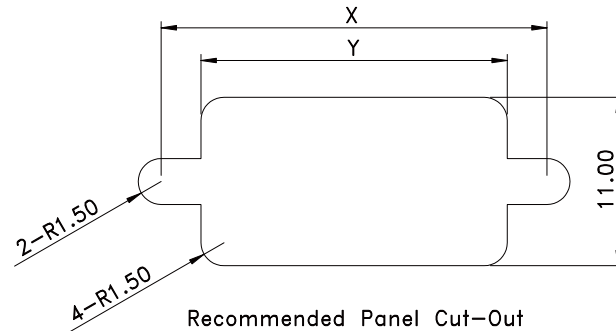
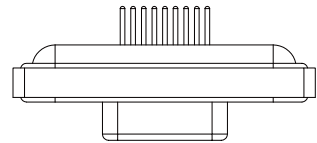
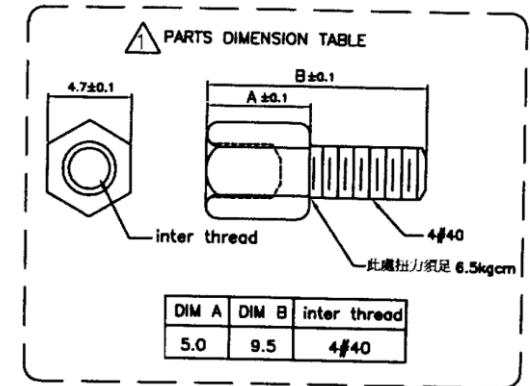

PIN	A	B	C	D	X	Y	Z
9	39.50	31.00	25.00	16.34	25.20	20	11.08
15	48.00	39.30	33.32	24.66	33.50	28.30	19.39
25	61.50	53.20	47.04	38.38	47.20	42.00	33.24
37	77.80	69.50	63.50	54.84	63.70	58.50	49.86

RoHS Compliant

MORETHANALL
 PCB CONNECTORS
 Cable ASSEMBLIES

煜倫股份有限公司

www.morethanall.com

DRAWING BY CY

CHECKED BY GENIUS

UNIT / mm

SCALE 1 : 1

DATE

SIZE A4

P PROJECTION

TOLERANCES ARE

X, ±
 .X ±
 .XX ±
 .XXX ±
 ANG ±



ORDER INFORMATION

WPDB-SDNH-xx-LF

SERIES | LEADFREE
 | 09-37WAY
 | HEX SCREW
 | NUT
 | DIP180°
 | FEMALE

DESCRIPTION: WATER-PROOF D-SUB (DIP180° FEMALE)