

Notes:

1. Material:

- * Insulator: High temperature plastic UL 94V-0, Color Nature
- * Contact: Phosphor bronze
- * TAB: Brass

2. For Lead Free IR Reflow process

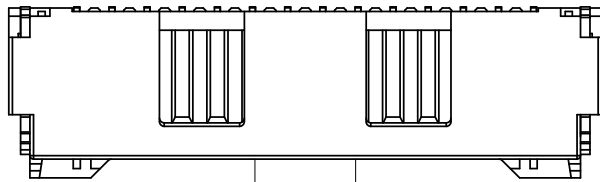

06P-15P Daul Hole

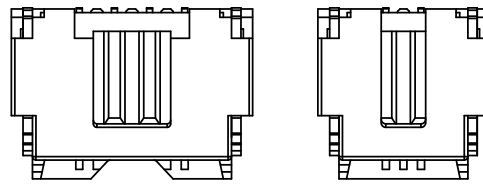
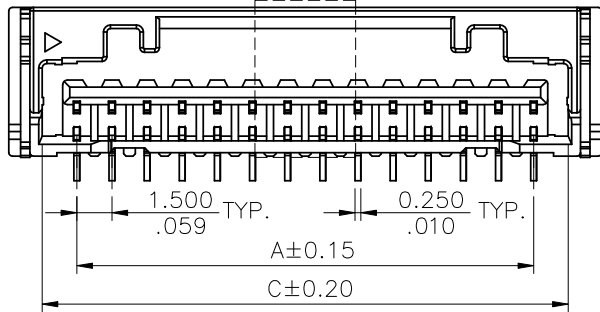

03P-05P Single Hole 02P Single Hole

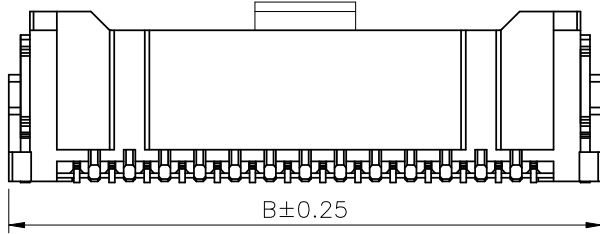

A = 1.50 x No. of Spaces
 B = A + 5.8
 C = A + 2.95

* Available in 2 through 15 circuits

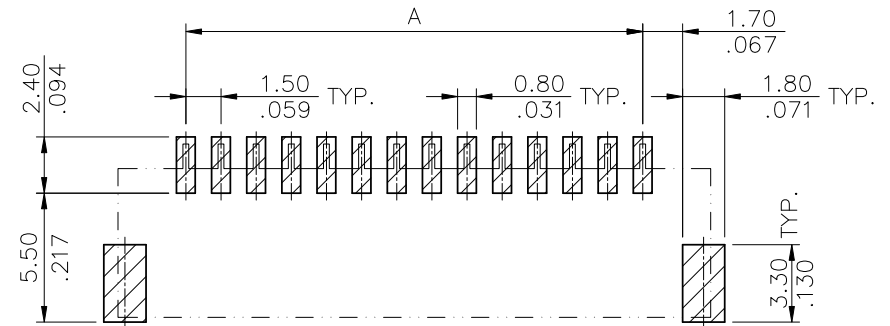
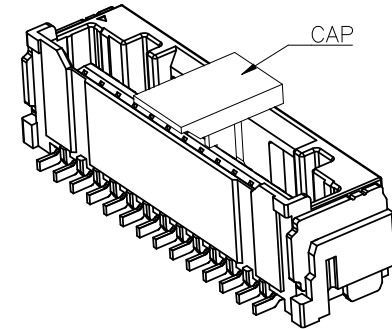
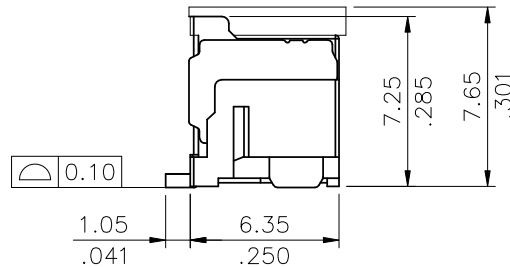

Recommended P.C. Board Layout
 General Tolerance ±0.05

RoHS Compliant



煜倫股份有限公司

www.morethanall.com

DRAWING BY CY

CHECKED BY GENIUS

UNIT / mm

SCALE 1 : 1

DATE

SIZE A4

PJECTION

TOLERANCES ARE

- X. ±
- .X ± 0.30
- .XX ± 0.20
- .XXX ± 0.10
- ANG ±

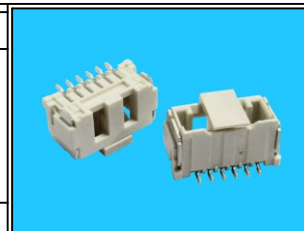

ORDER INFORMATION

CLM15-VXC-1Xxx-LF

SERIES | LEADFREE
 | 1X02:02WAY
 | 1X15:15WAY
 | CAP
 | NON POST
 | 180°SMT

DESCRIPTION:

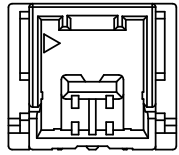

2 PIN

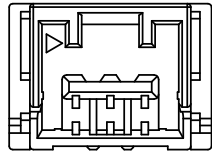

3 PIN

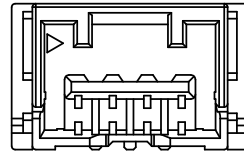

4 PIN

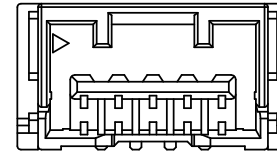

5 PIN

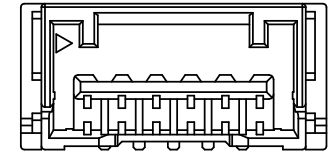

6 PIN

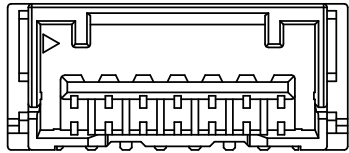

7 PIN

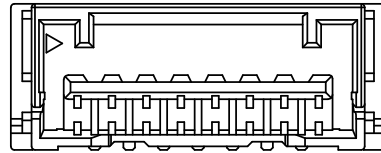

8 PIN

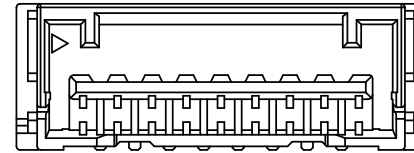

9 PIN

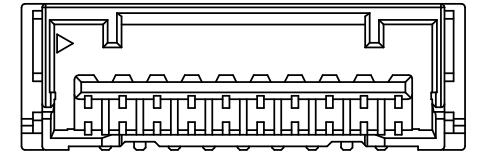

10 PIN

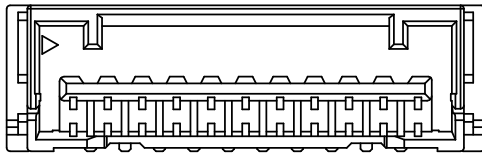

11 PIN

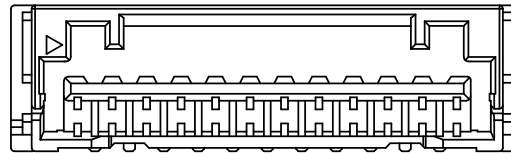

12 PIN

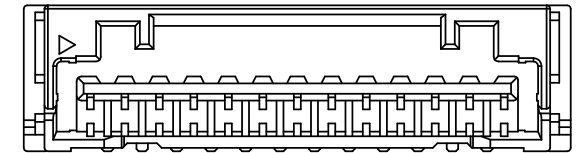

13 PIN

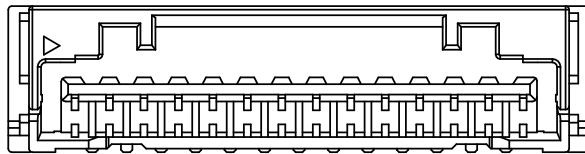

14 PIN

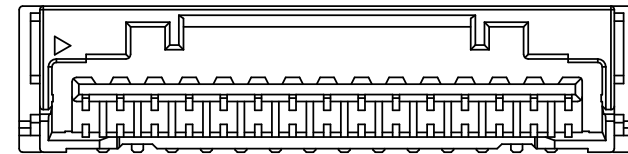

15 PIN

RoHS Compliant

TOLERANCES ARE

MORETHANALL
PCB CONNECTORS
Cable ASSEMBLIES

煜倫股份有限公司

www.morethanall.com

DRAWING BY CY

CHECKED BY GENIUS

UNIT / mm

SCALE 1 : 1

DATE

SIZE A4

X, ±
.X ± 0.30
.XX ± 0.20
.XXX ± 0.10
ANG ±

PJECTION

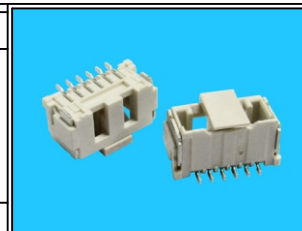

ORDER INFORMATION

CLM15-VXC-1Xxx-LF

SERIES

LEADFREE

1X02:02WAY

1X15:15WAY

CAP

NON POST

180°SMT

DESCRIPTION: