

NOTES:

1. MATERIAL:

- 1.1 HOUSING: THERMOPLASTIC, HIGH TEMP., UL94V-0.
- 1.2 CONTACT: COPPER ALLOY
- 1.3 FITTING NAIL: COPPER ALLOY

2. FINISH:

- 2.1 CONTACT:
 - 1:50U" NICKEL OVERALL, GOLD FLASH OVERALL
 - L:50U" NICKEL OVERALL, 120U" MIN. PURE TIN(MATT TIN) OVER ALL.
 - N:50U" NICKEL OVERALL, 120U" MIN. MATT TIN(LEAD-FREE) OVER ALL.

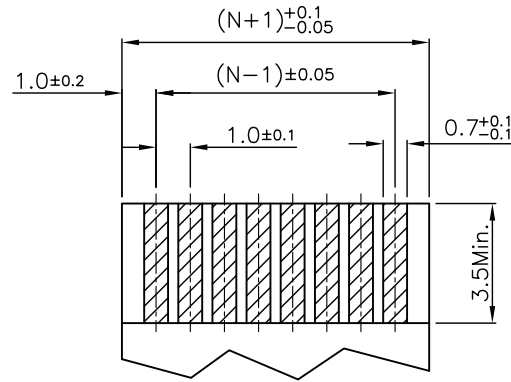

APPLICABLE FPC/FFC
RECOMMENDED DIMENSION
THICKNESS 0.3±0.03

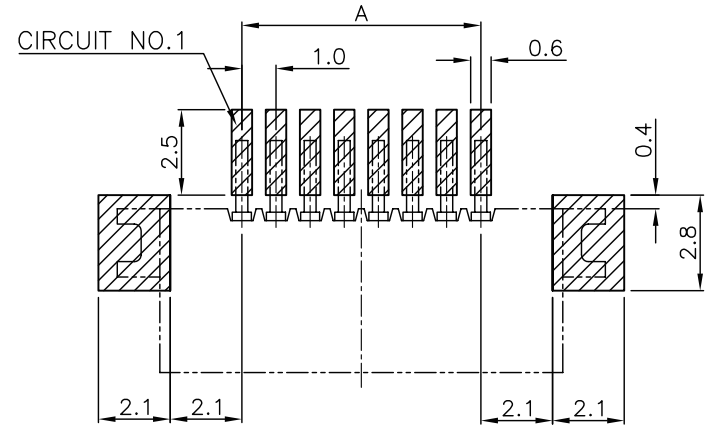

RECOMMENDED PCB LAYOUT
GENERAL TOLERANCE ±0.05

CKT	Dim A	Dim B	Dim C
4	3.0	5.1	8.0
5	4.0	6.1	9.0
6	5.0	7.1	10.0
7	6.0	8.1	11.0
8	7.0	9.1	12.0
9	8.0	10.1	13.0
10	9.0	11.1	14.0
11	10.0	12.1	15.0
12	11.0	13.1	16.0
13	12.0	14.1	17.0
14	13.0	15.1	18.0
15	14.0	16.1	19.0
16	15.0	17.1	20.0
17	16.0	18.1	21.0
18	17.0	19.1	22.0
19	18.0	20.1	23.0
20	19.0	21.1	24.0
21	20.0	22.1	25.0
22	21.0	23.1	26.0
23	22.0	24.1	27.0
24	23.0	25.1	28.0
25	24.0	26.1	29.0
26	25.0	27.1	30.0
27	26.0	28.1	31.0
28	27.0	29.1	32.0
29	28.0	30.1	33.0
30	29.0	31.1	34.0

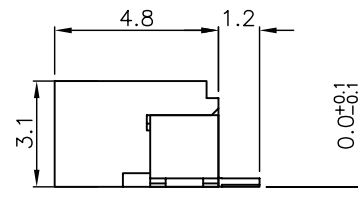
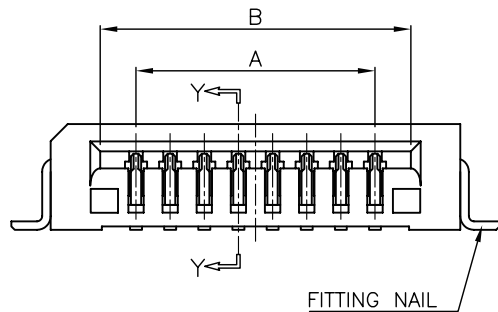
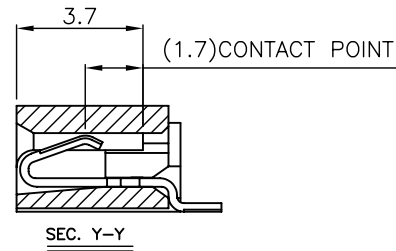
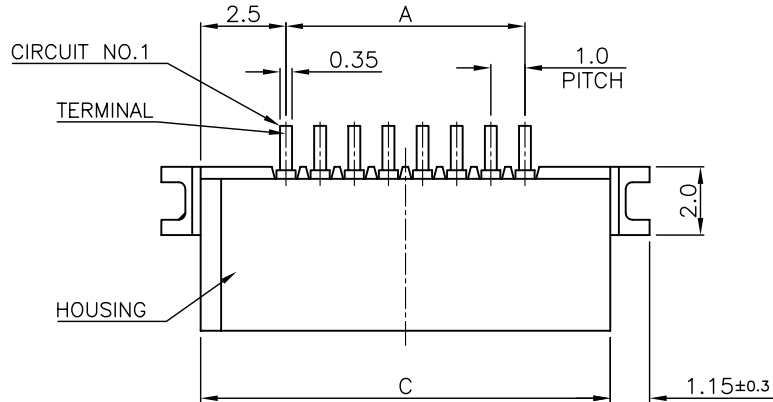

RoHS Compliant

TOLERANCES ARE

MORETHANALL
PCB CONNECTORS
Cable ASSEMBLIES

煜倫股份有限公司

www.morethanall.com

DRAWING BY CY

CHECKED BY GENIUS

UNIT/mm

SCALE 1:1

DATE

SIZE A4

PJECTION

X. ± 0.50
X ± 0.25
.XX ± 0.15
.XXX ± 0.1
ANG ± 2°

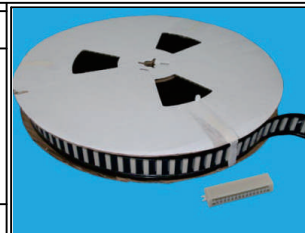

ORDER INFORMATION

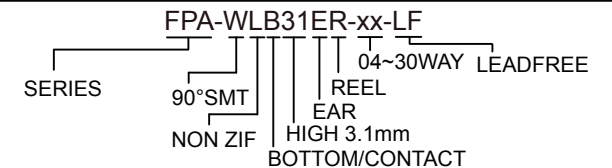

DESCRIPTION: 1.0mm NON ZIF FPC CONN SMT R/A (BOT. CONTACT)TYPE

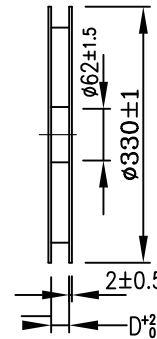
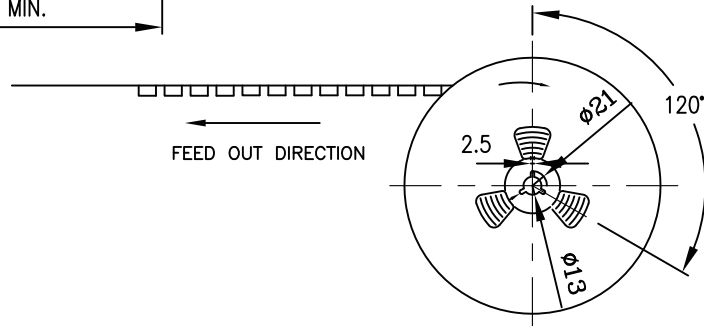
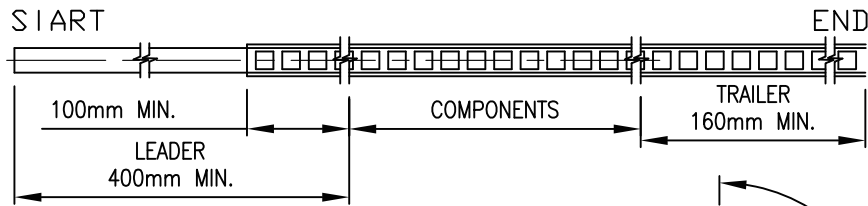

CKT.	A	B	C	D
3	11.50	7.30	24.00	24.00
4		8.30		
5		9.30		
6		10.30		
7		11.30		
8		12.30		
9		13.30		
10		14.30		

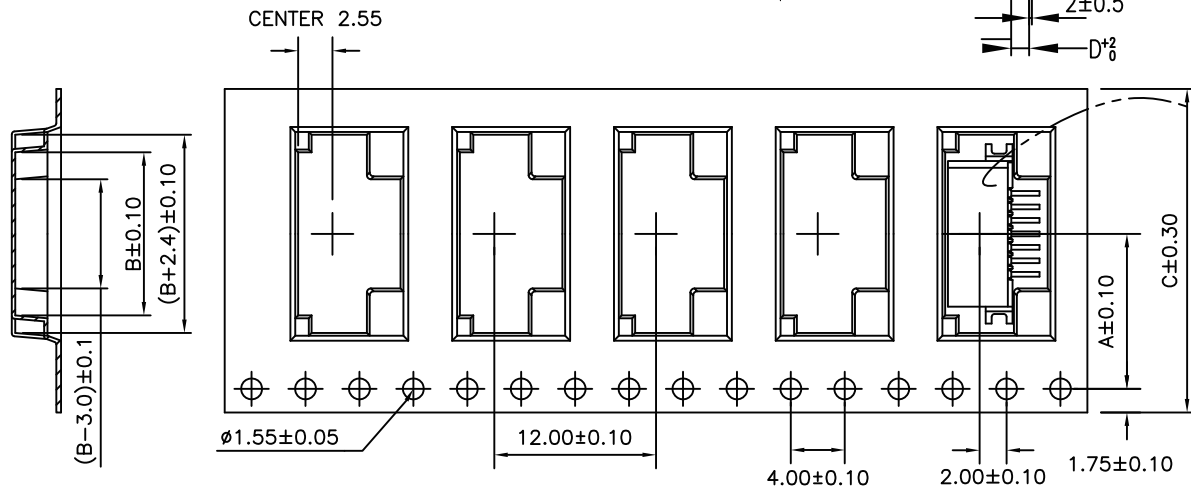

- NOTES:
- 10 SPROCKET HOLE PITCH CUMULATIVE TOLERANCE. ±0.20mm
 - CARRIER CAMBER NOT TO EXCEED 1mm IN 100mm.
 - ALL DIMENSIONS MEET EIA-481-C REQUIREMENTS.
 - MATERIAL: BLACK CONDUCTIVE POLYSTYRENE.
 - THICKNESS: 0.35±0.05 mm.
 - PACKING LENGTH PER 13" REEL : 19.0 METERS.
 - COMPONENT LOAD PER 13" REEL : 1500 PCS.

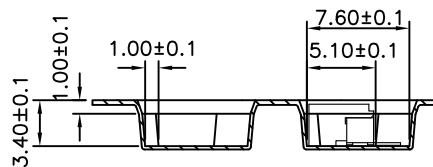

RoHS Compliant

TOLERANCES ARE

MORETHANALL
PCB CONNECTORS
Cable ASSEMBLIES

煜倫股份有限公司

www.morethanall.com

DRAWING BY CY

CHECKED BY GENIUS

UNIT/mm

SCALE 1:1

DATE

SIZE A4

X. ± 0.50

.X ± 0.25

.XX ± 0.15

.XXX ± 0.1

ANG ± 2°

PJECTION

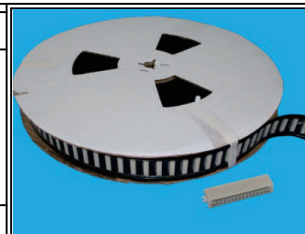

ORDER INFORMATION

FPA-WLB31ER-xx-LF

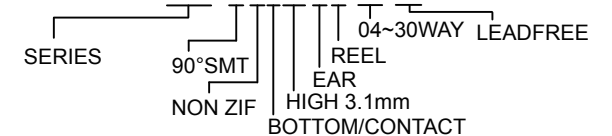

DESCRIPTION: 1.0mm NON ZIF FPC CONN SMT R/A (BOT. CONTACT)TYPE

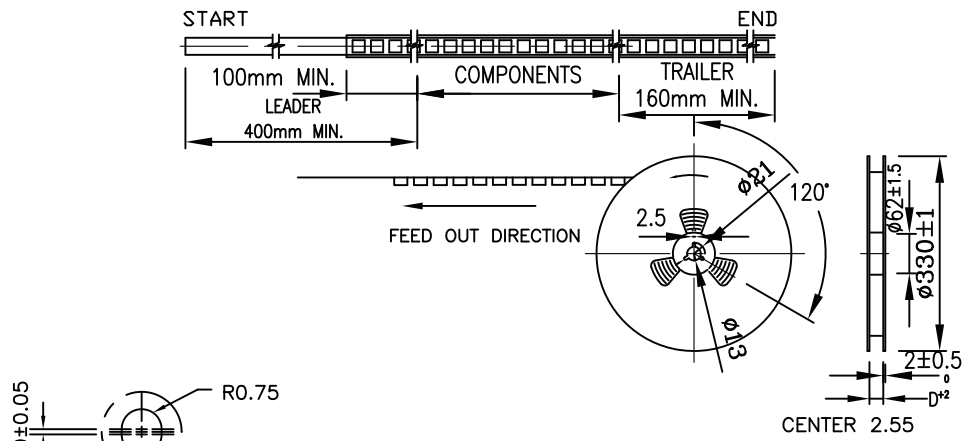

- NOTES:
1. 10 SPROCKET HOLE PITCH CUMULATIVE TOLERANCE. ±0.20mm
 2. CARRIER CAMBER NOT TO EXCEED 1mm IN 100mm.
 3. ALL DIMENSIONS MEET EIA-481-C REQUIREMENTS.
 4. MATERIAL: BLACK CONDUCTIVE POLYSTYRENE.
 5. THICKNESS: 0.35±0.05 mm.
 6. PACKING LENGTH PER 13" REEL : 19.0 METERS.
 7. COMPONENT LOAD PER 13" REEL : 1500 PCS.

CKT.	A	B	C	D	E
1		15.30			
12	14.2±0.10	16.30	32.00	32.40	28.70
13		17.30			
14		18.30			
15		19.30			
16		20.30			
17		21.30			
18		22.30			
19		23.30			
20	20.2±0.10	24.30	44.00	44.40	40.40
21		25.30			
22		26.30			
23		27.30			
24		28.30			
25		29.30			
26		30.30			
27		31.30			
28	26.2±0.10	32.30	56.00	56.10	52.40
29		33.30			
30		34.30			

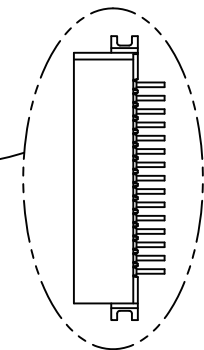
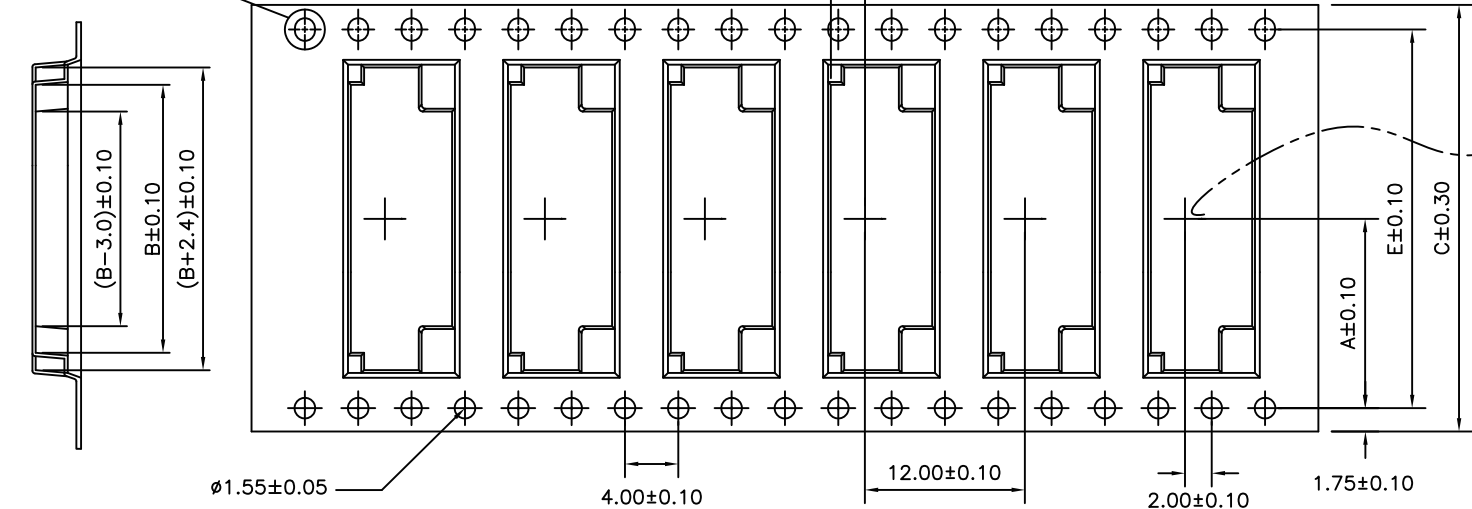
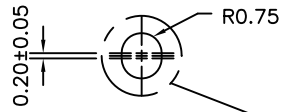

RoHS Compliant

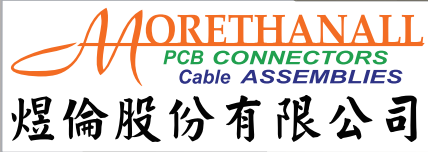

www.morethanall.com

DRAWING BY CY		TOLERANCES ARE X. ± 0.50 .X ± 0.25 .XX ± 0.15 .XXX ± 0.1 ANG ± 2°
CHECKED BY GENIUS		
UNIT/mm	SCALE 1:1	
DATE		
SIZE A4	P PROJECTION	

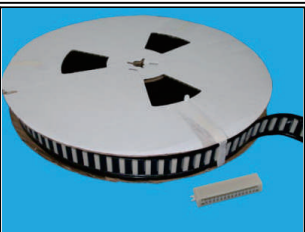

ORDER INFORMATION

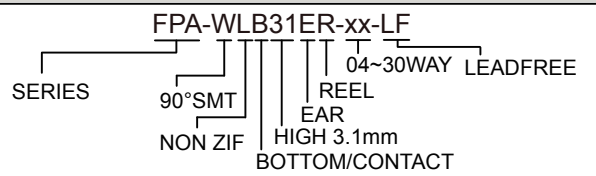

DESCRIPTION: 1.0mm NON ZIF FPC CONN SMT R/A (BOT. CONTACT)TYPE