

Ø A: 6, 6.5, 7, 7.5, 8, 8.5, 9 mm

RoHS Compliant

TOLERANCES ARE

**MORETHANALL**  
PCB CONNECTORS  
Cable ASSEMBLIES

煜倫股份有限公司

www.morethanall.com

DRAWING BY CY

CHECKED BY GENIUS

UNIT/mm

SCALE 1:1

DATE

SIZE A4

PJECTION

X. ±  
.X ±  
.XX ±  
.XXX ±  
ANG ±

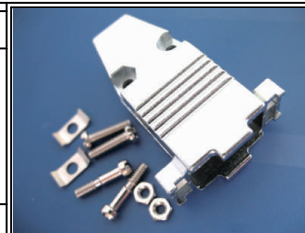

ORDER INFORMATION

DHV-C1Dxx-09-LF

SERIES  
CHROMATE  
09WAY LEADFREE  
D06: CABLE DIA 6.0mm  
D065: CABLE DIA 6.5mm  
SINGLE PACKING

DESCRIPTION: D-sub Connector hood

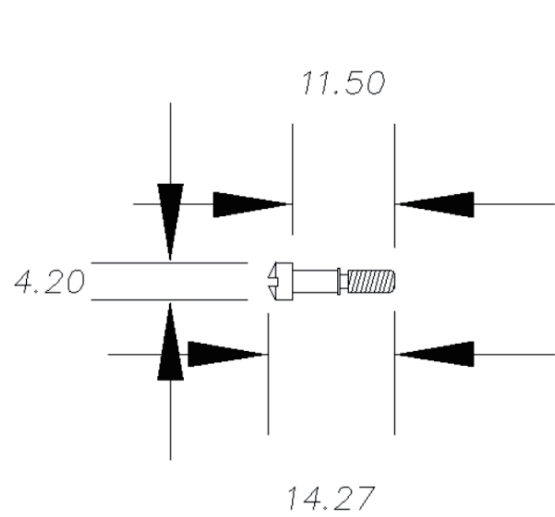

screw #4-11.5-0.5 UNC 4-40

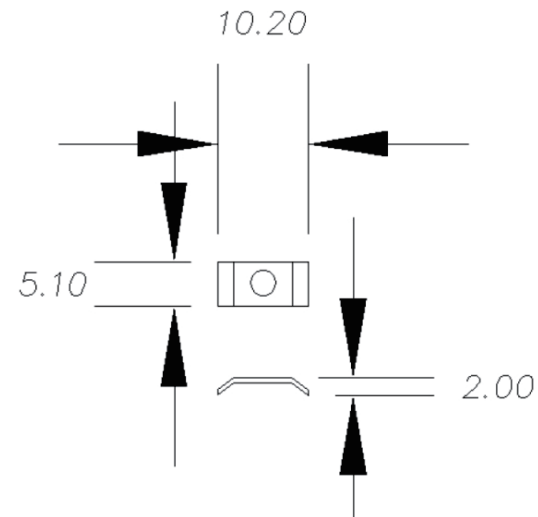

square washer for shoulder screw

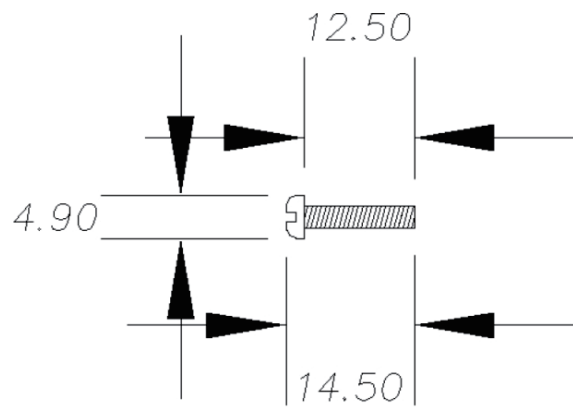

screw #4-12.5 UNC 4-40

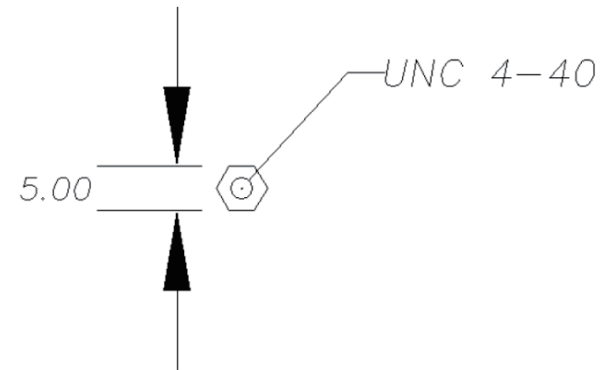

NUT

**RoHS Compliant**

TOLERANCES ARE

**MORETHANALL**  
PCB CONNECTORS  
Cable ASSEMBLIES

煜倫股份有限公司

www.morethanall.com

DRAWING BY CY

CHECKED BY GENIUS

UNIT/mm

SCALE 1:1

DATE

SIZE A4

PJECTION

X. ±  
.X ±  
.XX ±  
.XXX ±  
ANG ±

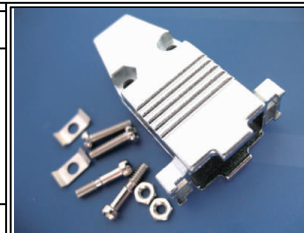

**ORDER INFORMATION**

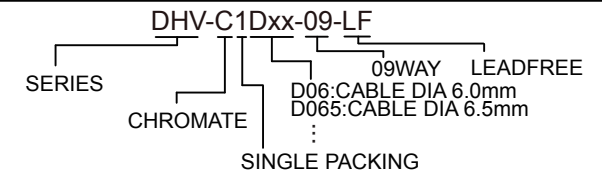

DESCRIPTION: