

MATERIAL
 INSULATOR:ABS UL94HB
 SCREW:STEEL
 FINISHED:CHROMATE PLATED

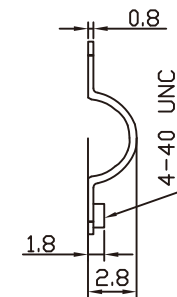
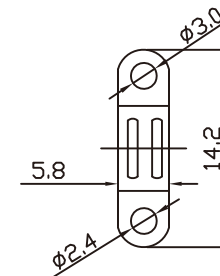
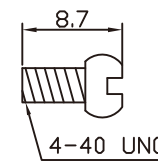
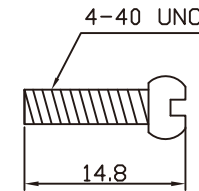
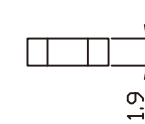
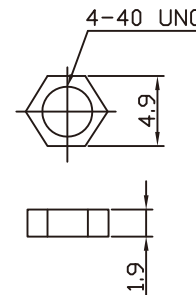
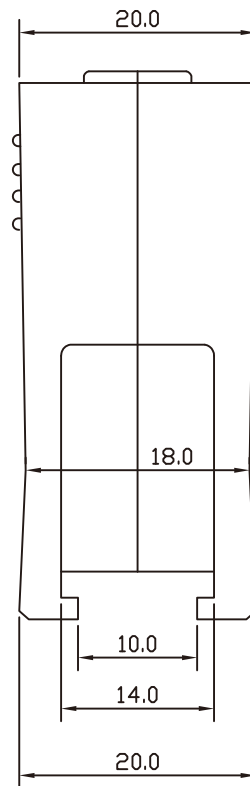
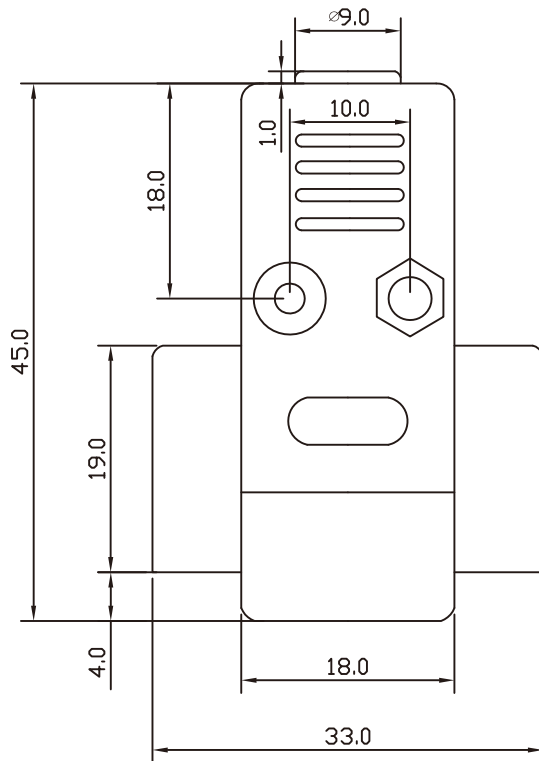

MORETHANALL
 PCB CONNECTORS
 Cable ASSEMBLIES

煜倫股份有限公司

www.morethanall.com

RoHS Compliant

DRAWING BY CY

CHECKED BY GENIUS

UNIT/mm SCALE 1:1

DATE

SIZE A4

TOLERANCES ARE

X. ±
 .X ±
 .XX ±
 .XXX ±
 ANG ±

PJECTION



ORDER INFORMATION

DHL-G1T-09-LF

SERIES | | LEADFREE
 | | 09WAY
 | | THUMBSCREW
 | | SINGLE PACKING
 | | GRAY

DESCRIPTION: