

## 一、Mechanical Dimensions

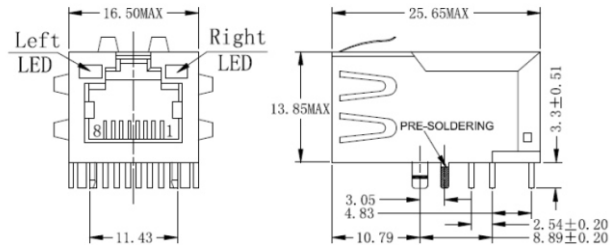

UNIT:mm Unless otherwise specified, all tolerances are  $\pm 0.25$

## 二、Schematics

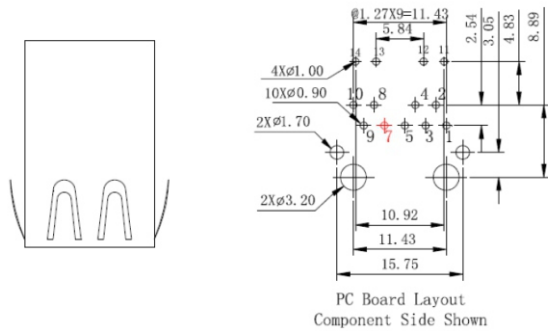
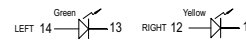
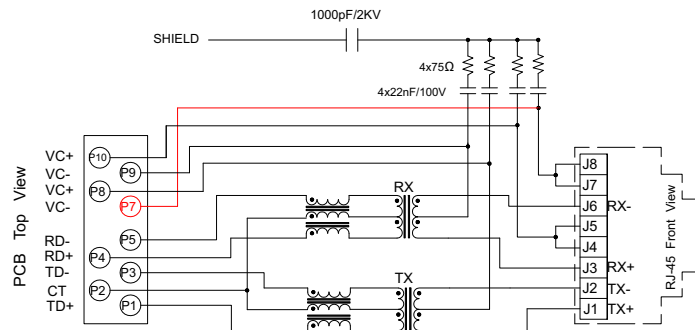

Standard LED	Wavelength	Forward*V(MAX)	TYP
Green	565nm	2.5v	2.2v
Yellow	585nm	2.5v	2.1v

With a forward current of 20mA

## 三、ELECTRICAL SPECIFICATIONS@25°C:

1. Turn Ratio(?%): 1CT:1CT
2. OCL(100KHz/0.1V@8mA): 350uH MIN@ 0°C~+70°C.
3. Insertion Loss(dB MAX): -1.5dB (1-100MHz)
4. Return Loss(dB MIN): -16dB(1-30MHz), -10dB(60-80MHz)
5. Cross talk(dB MIN): -30dB(1-100MHz)
6. DCR:(P1-P3,P4-P5): 1.2Ω MAX
7. DCR:(J1-J2,J3-J6): 0.8Ω MAX
8. HI-POT : 2000Vrms/0.5mA/2s
9. Operating Temperature: -40°C TO +85°C
10. POE applications current capability: 700mA
11. RoHS compliance:YES

RoHS Compliant

TOLERANCES ARE

**MORETHANALL**  
PCB CONNECTORS  
Cable ASSEMBLIES  
煜倫股份有限公司

DRAWING BY CY

CHECKED BY GENIUS

UNIT / mm

SCALE 1 : 1

DATE

SIZE A4

PJECTION

X. ±  
.X ±  
.XX ±  
.XXX ±  
ANG ±

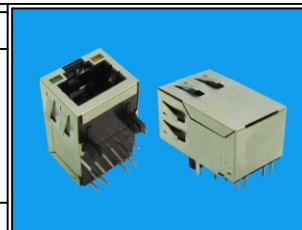

ORDER INFORMATION

MJF13P02UL-KF06B3GY-0808

SERIES

06u" GOLD

FULL SPRING

BLACK

8P8C

LEFT / RIGHT

GY: GREEN / YELLOW  
REAR TAB 3.05mm

DESCRIPTION: 10/100 Base-T POE+ Single Port Rj-45 Jack Magnetics

www.morethanall.com

#### 四、Mechanicals

##### Housing Material:

MATERIAL:NYLON 66 UL94V-0 STANDARD COLOR:BLACK

##### Insert Material:

MATERIAL:Phos-Bronze C5210 EH---0.35mm Thickness

Insert PBT GF UL94V-0

1.PLATING(1) NICKEL

2.PLATING(2) 100%Sn

3.PLATING(3) GOLD (3u " ~50u " )

##### Plate Material:

PBT GF UL 94V-0

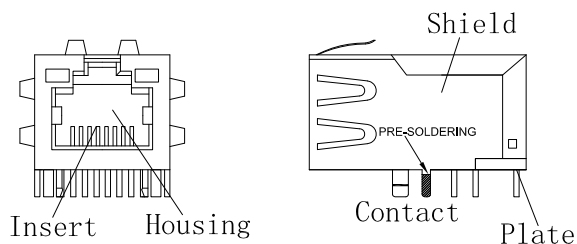

##### Contact pin Material:

MATERIAL: Phos-Bronze C5191---0.35mm Thickness

1.PLATING(1) NICKEL

2.PLATING(2) 100%Sn

##### Shielding Material:

BRASS C2680 PLATING NICKEL

Operating Life:750 Cycles MIN.

#### 五、Environmental

1.Storage Temp:-40°C TO +85°C.

2.Operating Temp: -40°C TO +85°C.

3.MATES WITH MODULAR PLUG CONFORMING TO FCC PART 68,SUBPART F.

#### 六、Packaging

1. packaging unit : 60 PCS/tray
2. packaging material : PET

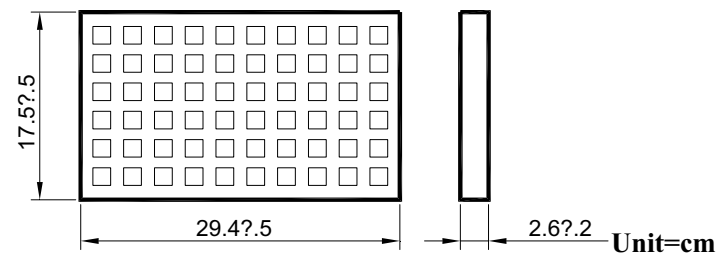

3. outer carton unit : 1080 pcs/ 18 Trays/box

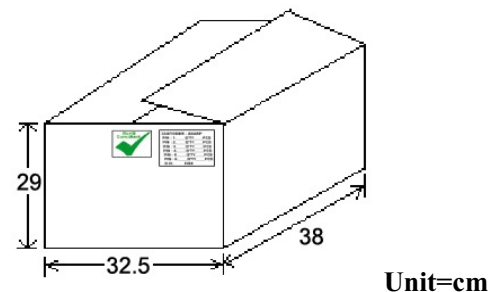

RoHS Compliant

TOLERANCES ARE

**MORETHANALL**  
PCB CONNECTORS  
Cable ASSEMBLIES

煜倫股份有限公司

www.morethanall.com

DRAWING BY CY

CHECKED BY GENIUS

UNIT / mm SCALE 1 : 1

DATE

SIZE A4

PPOJECTION

X. ±  
.X ±  
.XX ±  
.XXX ±  
ANG ±

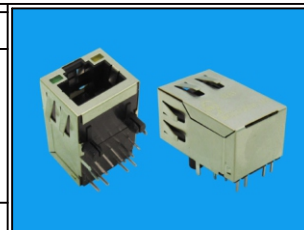

ORDER INFORMATION

MJF13P02UL-KF06B3GY-0808

SERIES

06u" GOLD  
FULL SPRING  
BLACK

8P8C

LEFT / RIGHT  
GY: GREEN / YELLOW  
REAR TAB 3.05mm

DESCRIPTION: 10/100 Base-T POE+ Single Port Rj-45 Jack Magnetics