

- NOTES:
1. MATERIAL:
 - 1.1 HOUSING: THERMOPLASTIC,HIGH TEMP.UL94V-0; COLOR: NATURAL
 - 1.2 ACTUATOR: THERMOPLASTIC,HIGH TEMP.UL94V-0; COLOR: BLACK
 - 1.3 CONTACT: COPPER ALLOY
 - 1.4 FITTING NAIL: COPPER ALLOY
 2. FINISH:
 - 2.1 CONTACT:
 - M: 50u" MIN. NICKEL PLATING OVERALL
 - 3u" MIN. GOLD PLATING ON CONTACT
 - PLATING GOLD FLASH ON SMT
 - 2.2 FITTING NAIL:
 - 100u" MIN. MATT TIN PLATING ON SOLDER TAILS(LEAD FREE).
 - 50u" MIN. NICKEL UNDERPLATNG OVERALL.

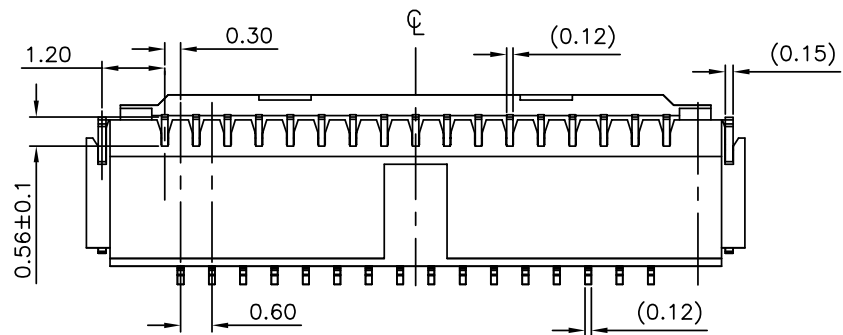
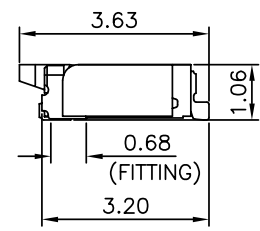
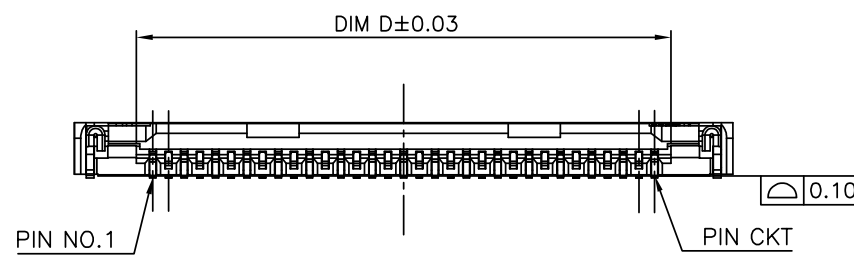

CKT	DIM A	DIM B	DIM C	DIM D	DIM E	DIM F
23	9.60	6.60	6.00	7.23	7.20	8.30
25	10.20	7.20	6.60	7.83	7.80	8.90
29	11.40	8.40	7.80	9.03	9.00	10.10
33	12.60	9.60	9.00	10.23	10.20	11.30
45	16.20	13.20	12.60	13.83	13.80	14.90
49	17.40	14.40	13.80	15.03	15.00	16.10
51	18.00	15.00	14.40	15.63	15.60	16.70

RoHS Compliant

TOLERANCES ARE



DRAWING BY CY X. ± 0.50
 CHECKED BY GENIUS .X ± 0.25
 UNIT / mm SCALE 1 : 1 .XX ± 0.15
 DATE .XXX ± 0.10
 SIZE A4 PPROJECTION ANG ± 2°

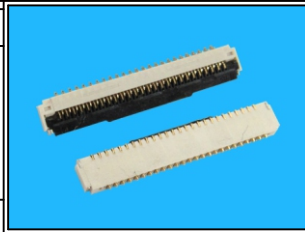

ORDER INFORMATION

FPT-WHB10FK-xx-LF
 SERIES | | | LEADFREE
 | | | 23-51WAY
 | | | FPC LOCK
 90°SMT | | | HIGH 1.06mm
 | | | BOTTOM CONTACT
 | | | HINGED ZIF

煜倫股份有限公司

www.morethanall.com

DESCRIPTION: 0.3 MM PITCH EASY ON FPC CONN. SMT R/A B/C TYPE

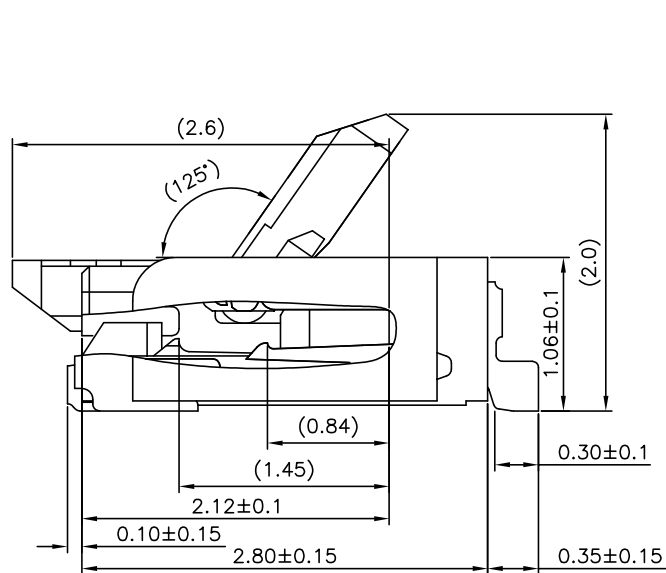

SCALE 3:1

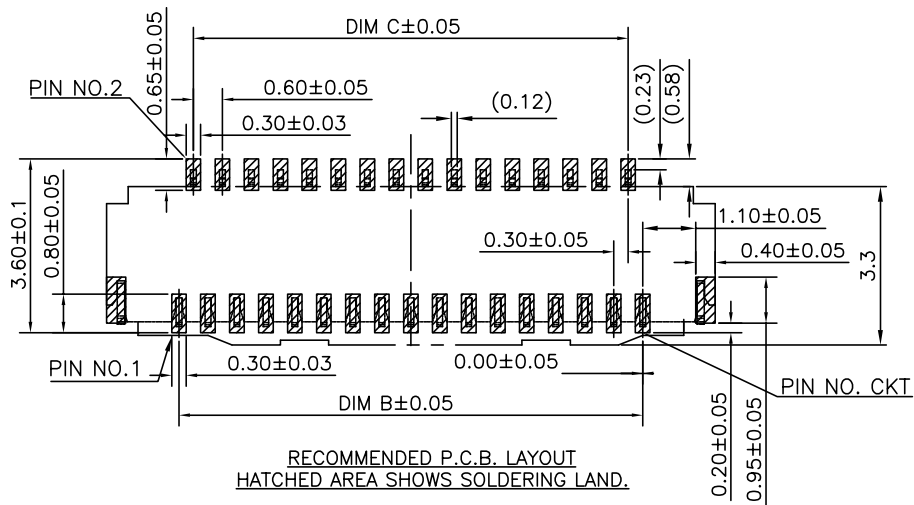

RECOMMENDED P.C.B. LAYOUT
 HATCHED AREA SHOWS SOLDERING LAND.
 (GENERAL TOLERANCE: ±0.05mm)

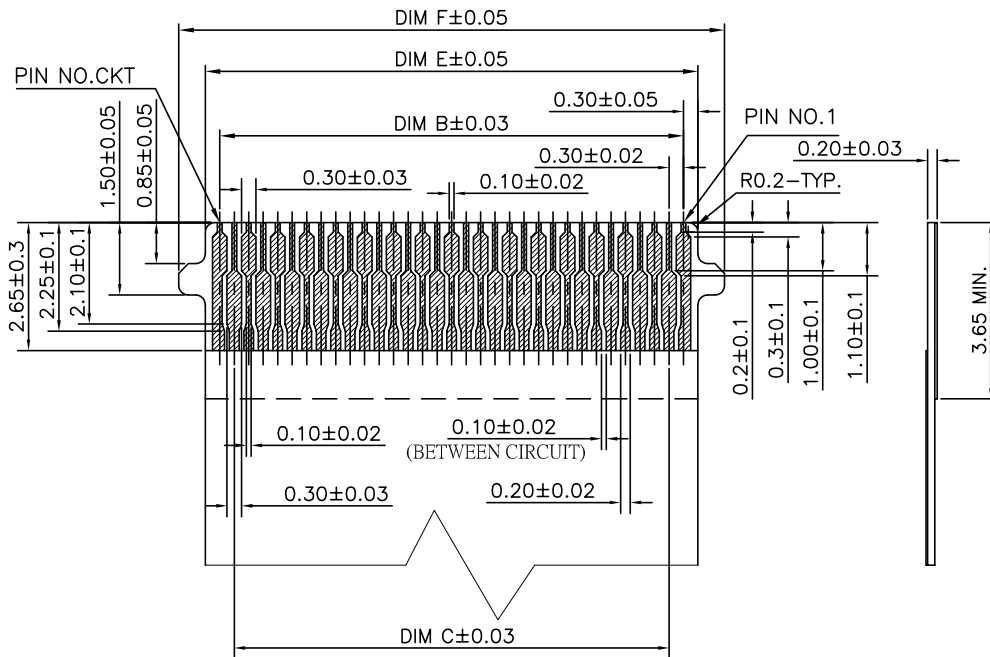

APPLICABLE FPC RECOMMENDED DIM
 (GENERAL TOLERANCE: ±0.05mm)



煜倫股份有限公司

www.morethanall.com

RoHS Compliant

DRAWING BY CY
 CHECKED BY GENIUS
 UNIT / mm SCALE 1:1
 DATE
 SIZE A4 PPROJECTION

TOLERANCES ARE

X ± 0.50
 .X ± 0.25
 .XX ± 0.15
 .XXX ± 0.10
 ANG ± 2°

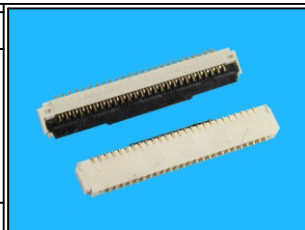

ORDER INFORMATION

FPT-WHB10FK-xx-LF
 SERIES | | | LEADFREE
 | | | 23-51WAY
 | | | FPC LOCK
 90°SMT | | | HIGH 1.06mm
 | | | BOTTOM CONTACT
 | | | HINGED ZIF

DESCRIPTION: 0.3 MM PITCH EASY ON FPC CONN. SMT R/A B/C TYPE