

Standard: IEC 320 C14
 Rating: 15A 250V AC
 Approvals: UL/CSA

Rating: 10A 250V AC
 Approvals: VDE/SEMKO/CCC

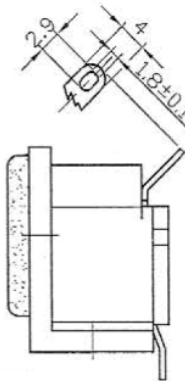
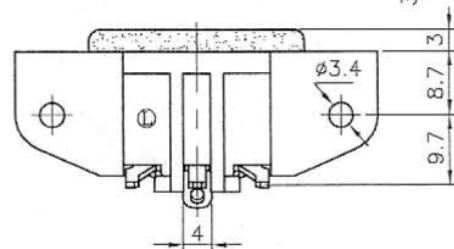
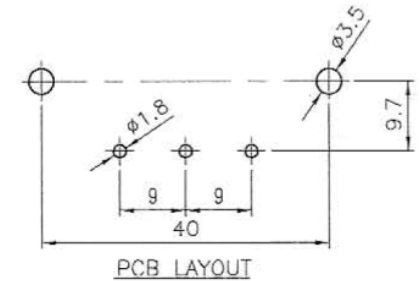
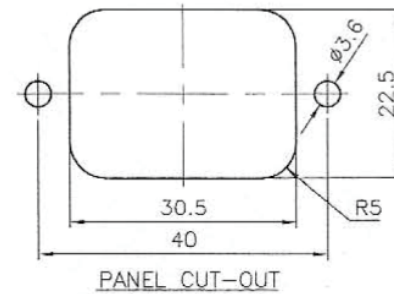
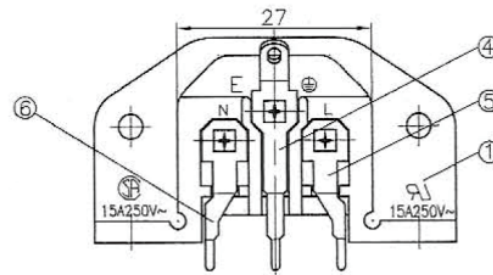
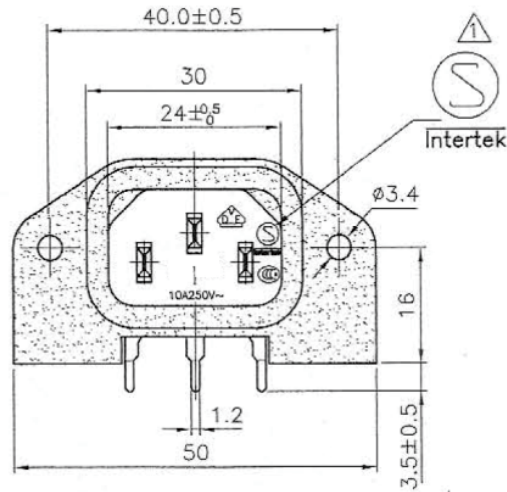

6	Soldering PIN Brass Strip t=0.8mm Tin-Plated	1
5	Soldering PIN Brass Strip t=0.8mm Tin-Plated	1
4	Soldering PIN Brass Strip t=0.8mm Tin-Plated	1
3	Contact PIN Brass Strip t=2mm Ni-Plated	2
2	Contact PIN Brass Strip t=2mm Ni-Plated	1
1	Body Insulator NYLON	1

RoHS Compliant

TOLERANCES ARE

MORETHANALL
 PCB CONNECTORS
 Cable ASSEMBLIES

煜倫股份有限公司

www.morethanall.com

DRAWING BY CY

CHECKED BY GENIUS

UNIT/mm SCALE 1:1

DATE

SIZE A4

P PROJECTION

X, ±
 .X ±
 .XX ±
 .XXX ±
 ANG ±

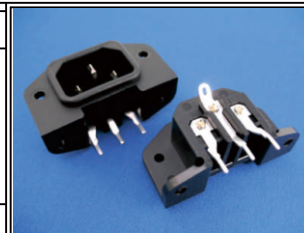

ORDER INFORMATION

ACF-PR9PE-03-LF
 SERIES | | | LEADFREE
 | | | 03WAY
 | | | PANEL EAR
 | | | PIN TO PIN 9.0mm
 | | | DIP 90°
 | | | MALE

DESCRIPTION: